

LITE

RENAULT T



Instrucciones de Montaje

Mounting Instructions

Instructions de Montage

Istruzioni di Montaggio

Instruções de Montagem

ES

EN

FR

IT

PT

Gracias por su adquisición y por confiar en nuestra gama de productos. **LITE** es un equipo de aire acondicionado diseñado y fabricado por **Dirna Bergstrom** para ser utilizado en un vehículo a motor parado durante los períodos de descanso a la sombra y/o por la noche.

LITE está diseñado con la más avanzada tecnología para lograr un eficaz rendimiento, una reducción en el gasto de combustible y en las emisiones de CO₂ a la atmósfera. Son estas características lo que lo hace único en el mercado del aire acondicionado para vehículos.



Lea atentamente este documento antes de instalar el producto. Conserve este documento para futuras consultas. La documentación original ha sido escrita en español, por lo que el resto de idiomas son traducciones.

Tiene a su disposición todos los manuales del producto en sus versiones digital (PDF) en <https://www.dirna.com/>

Cualquier operación de venta o de garantía está sometida a nuestras condiciones generales de venta en su versión más actualizada, publicada en nuestra página web <https://www.dirna.com/>

Explicación de símbolos



- **Advertencia:** Aviso de seguridad que informa sobre una situación, que de no evitarse, puede provocar lesiones graves o la muerte.



- **Peligro:** Riesgo de corte. Señala una situación que podría provocar un corte.



- **Peligro:** Riesgo de electrocución. Señala una situación que podría provocar una electrocución.



- **Aviso:** Aviso de seguridad que informa sobre una situación, que de no evitarse, puede provocar daños al equipo o a otros materiales.



- **Información:** Información adicional sobre la instalación o el manejo del producto.



- **Frágil:** Indica una situación en la que se debe operar con cuidado para no causar daños al equipo y a otros materiales.



Explicación de responsabilidades

- **Dirna Bergstrom** declina toda responsabilidad ante los daños ocasionados en los siguientes casos:

- Daños en el producto debido a influencias mecánicas y sobretensiones.
 - Modificaciones realizadas en el equipo sin el consentimiento expreso del fabricante.
 - Utilización el equipo para fines no descritos en este documento.
 - Una inadecuada manipulación o instalación del equipo.
- Queda prohibida la manipulación de los circuitos de gas refrigerante sin autorización expresa del fabricante.



Advertencias durante el montaje

- La instalación, reparación y mantenimiento de este equipo de aire acondicionado solo puede ser realizada por aquel personal técnico que posea una formación suficiente en aire acondicionado para vehículos, posibles peligros y normas aplicables.
- Leer detenidamente las instrucciones de montaje antes de iniciar la instalación del equipo. Durante la instalación, seguir al pie de la letra las instrucciones indicadas.
- Desconectar la llave de contacto antes de iniciar la instalación del equipo.
- Desconectar la batería del vehículo antes de iniciar la instalación del equipo.
- Instale **LITE** de forma segura para evitar caídas.
- Utilizar las herramientas adecuadas para cada operación.
- Durante la instalación, asegurar la conexión de los componentes eléctricos, verificando su encaje correcto.
- Si en la instalación del equipo los cableados atraviesan paredes con bordes afilados, utilice conductos o guías para evitar que los cables se dañen.
- Si durante la instalación el equipo se inclina, o la cabina se abate con el equipo instalado sobre ella, deberá esperarse un mínimo de 60 minutos, desde que el equipo quede horizontal, antes de ponerlo en marcha.
- Equipo precargado con gas refrigerante r-134a.



- **Aviso importante:** Tenga la precaución al conectar el equipo de no invertir las polaridades. Si esto sucediera, la placa de mandos no se encenderá y el equipo no se pondrá en funcionamiento.



Herramientas necesarias para el montaje

- Juego de llaves Torx
- Llave fija 10, 13, 14
- Tijeras
- Flexómetro
- Destornillador



Uso adecuado del producto

- **LITE** es un equipo de aire acondicionado de techo apropiado para ser utilizado únicamente en camiones. No es adecuada su instalación y funcionamiento en maquinaria agrícola ni de construcción sujeta a intensas vibraciones.
- El uso no conforme al previsto anula la garantía del equipo y excluye de responsabilidad al fabricante.
- Si no está seguro de cómo utilizar **LITE**, revise el manual de usuario del producto.
- Si la temperatura en la cabina de su vehículo es muy elevada para el descanso, enfríe primero la cabina con el aire acondicionado de su vehículo durante algunos minutos y después ponga en marcha **LITE** para mantener la temperatura de confort.



Documentación relacionada

- Guía rápida: 1001335086
- Manual de usuario: 1001335089
- Listado de recambios: 1003229123
- Diagnóstico de averías: 1001335088

Dirna Bergstrom declara que el equipo **LITE** cumple con los requerimientos de las siguientes Directivas CE y que se han aplicado las normas y especificaciones técnicas armonizadas enumeradas a continuación:

- Directiva CE 2014/53/EU
- Directiva CE 2011/65/EU
- Directiva CE 2014/30/EU

1 Desmontar consola original, tirando del extremo de las luces para acceder a los tornillos de fijación.
En el caso de llevar leds (*) desmontar tirando de ellos.



2 Desmontar escotilla quitando tornillos de fijación de la misma (en escotilla eléctrica desconectar clema (*) de la misma).

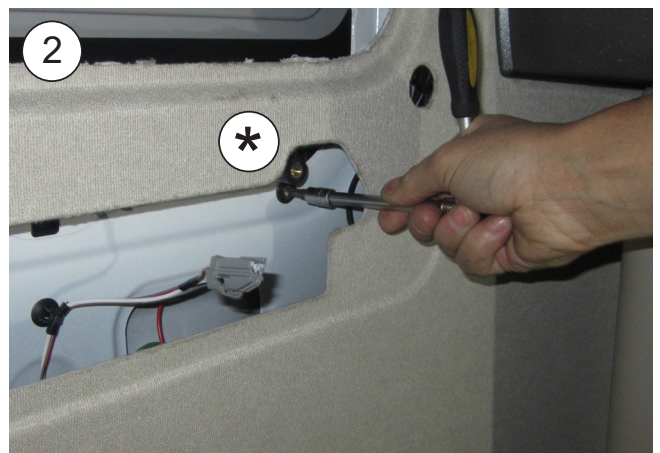

3 Limpiar contorno escotilla y pegar junta EPDM 25x15, por el exterior del resalte del contorno del hueco de la escotilla.



4 **COMO CORTAR LA JUNTA EPDM PARA EVITAR FILTRACIÓN DE AGUA EN LA CABINA**

A- Pegar la junta, manteniendo 100 mm de papel protector por cada lado.

B- Quitar los dos piezas de papel.

C- Pegue presionado ambos finales.

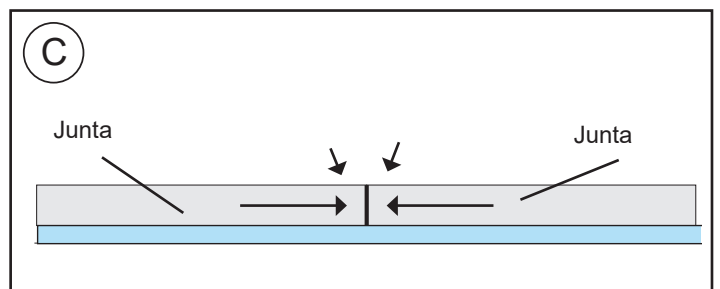
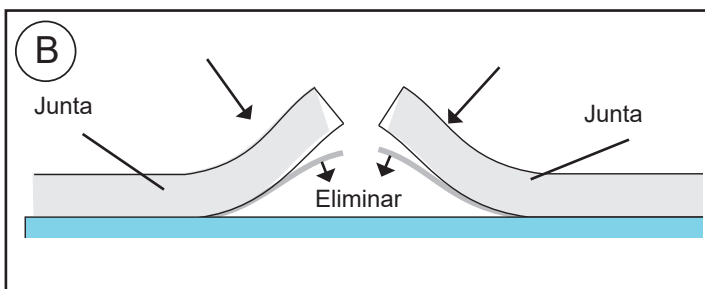
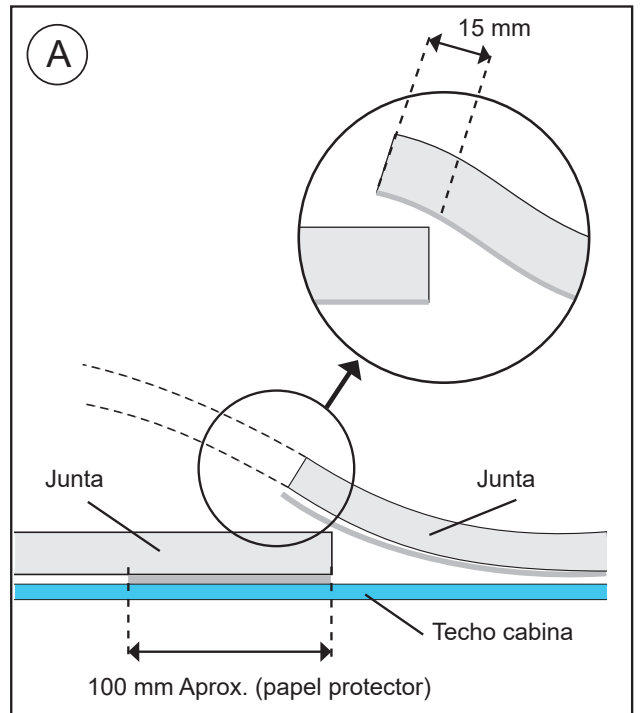

5 Insertar (4) tornillos M6/100 en cada soporte de fijación antes de montarlos en la base del equipo como se muestra en la imagen. Al no estar fijados los tornillos al soporte, tener precaución al voltear el soporte para fijarlo en la base.

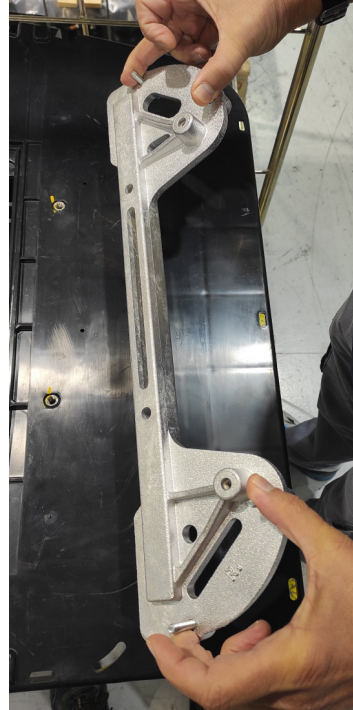
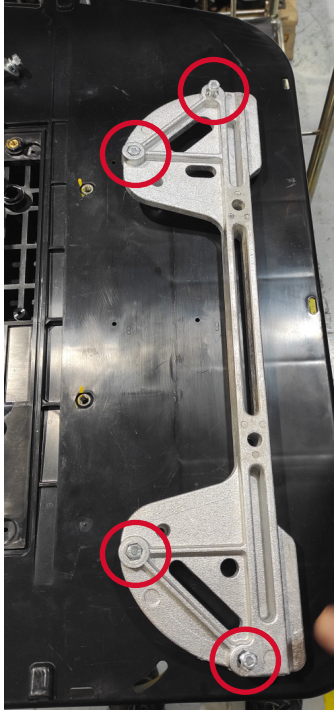

6 Fijar soporte de fijación derecho (marcado con una "R") y soporte de fijación izquierdo (marcado con una "L") en la base del equipo utilizando (4) arandelas grower, (4) arandelas planas de 8 mm y (4) tornillos M8/125.

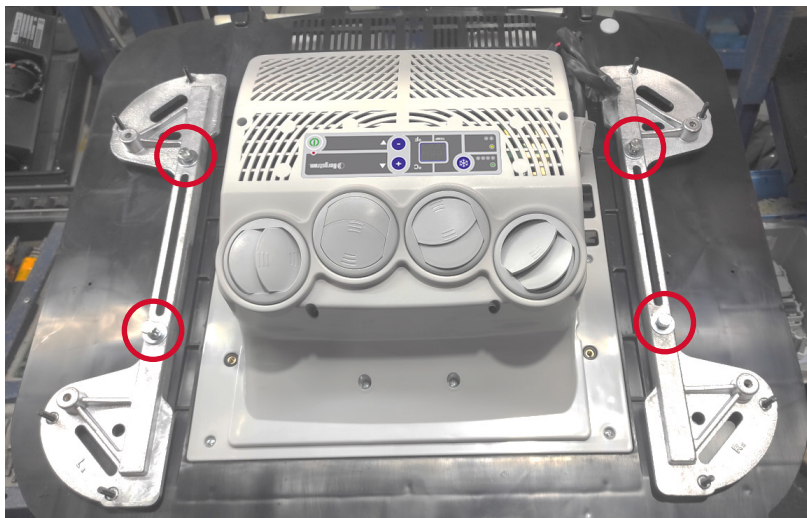

7

Posicionar equipo encajando soportes sobre el hueco de la escotilla.

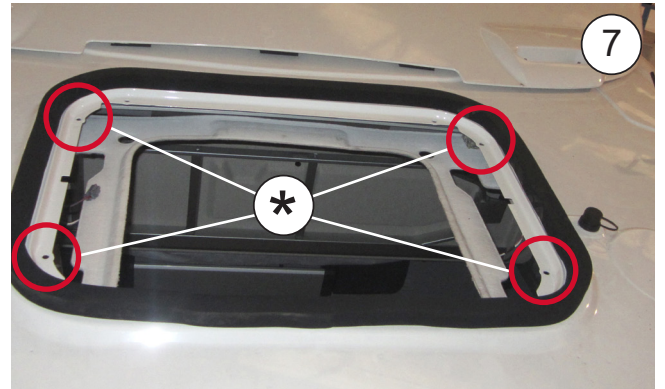
**8**

Roscar (8) tuercas M6/100 con arandela en cada espárrago de los soportes. Apretar éstas con un par de apriete de $10 \pm 10\%$ Nm.

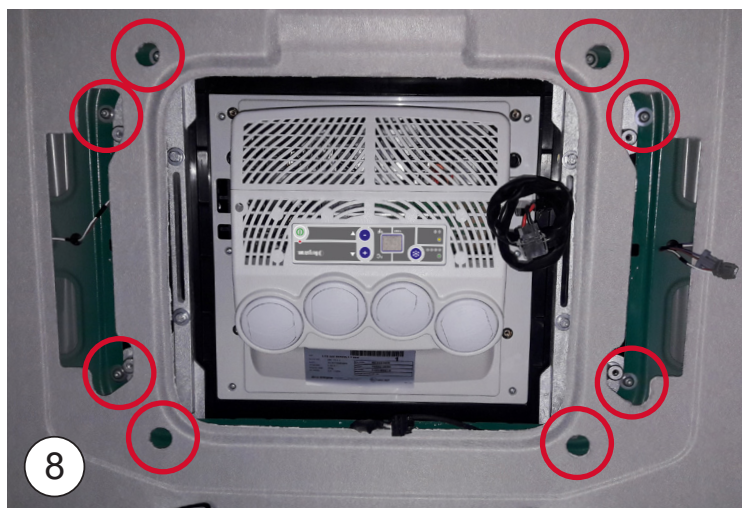

CONEXIÓN CABLEADO

9

Llevar cables de alimentación hasta la escotilla y grapar en estos los terminales suministrados y colocar caja de 2 vías suministrada.

Atención: Hacer coincidir cables según se indica R= (+) y N= (-).

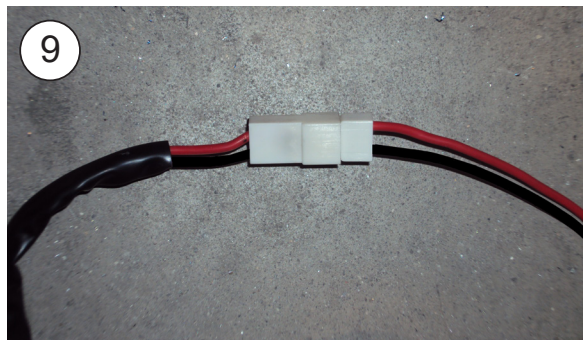

Atención: El cableado que se debe instalar debe ser de 6 mm de sección, el cable (+) debe ir protegido con un fusible de 30A.

Importante: Debido al complejo sistema de regulación electrónica del equipo, la toma de corriente debe realizarse directamente a la batería o a un punto autorizado, no a cualquier otro punto que de servicio a otros accesorios del vehículo, teniendo la precaución de no invertir la polaridad al realizar la conexión.

Importante: Para la puesta en marcha consultar el **manual de usuario**.

- 10** Introducir consola en frente y fijarla con (4) tornillos 6/100x30 con arandela, roscando en los separadores indicados de los soportes con un par de apriete de $3,0 \pm 10\%$ Nm.

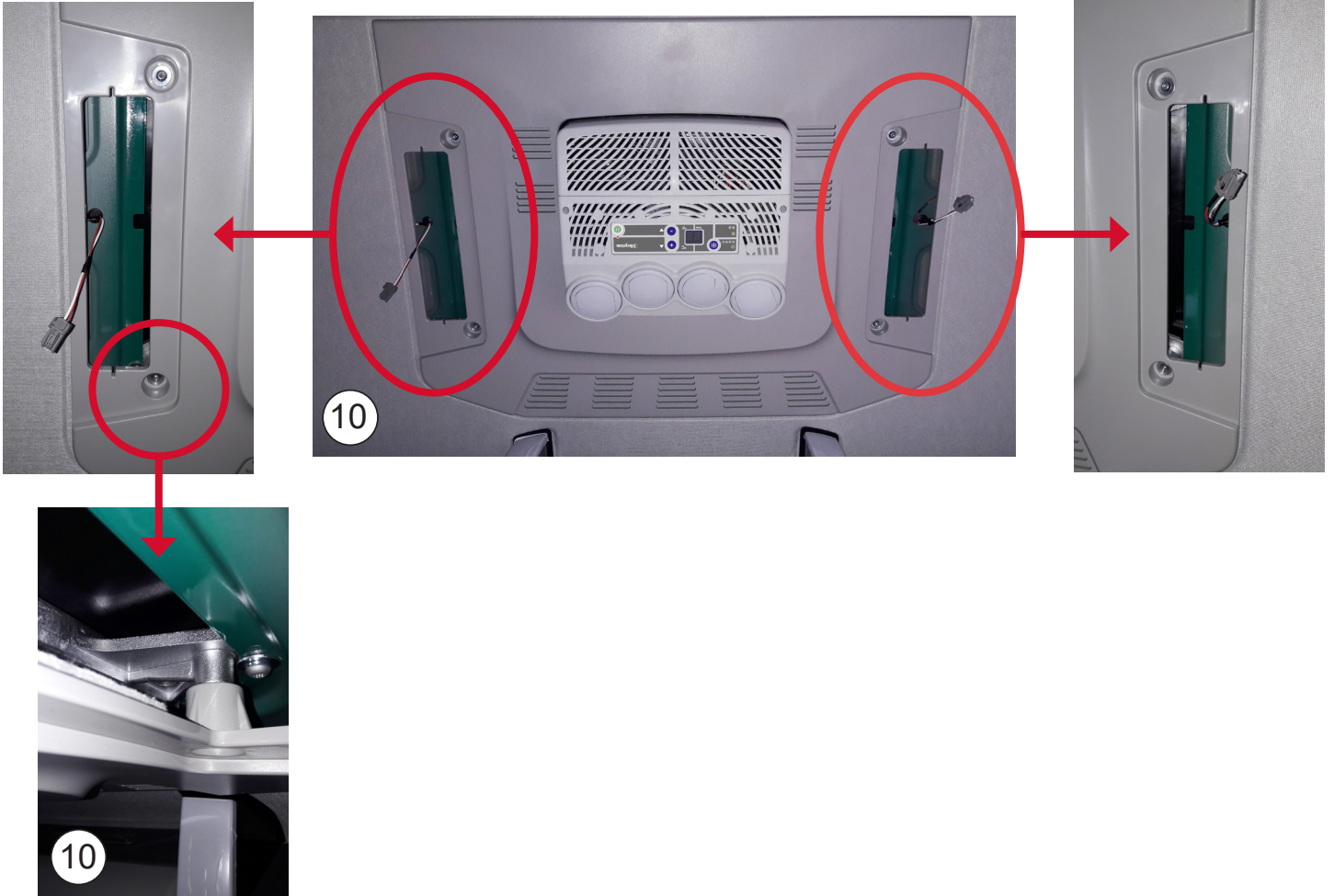

- 11** Conectar luces e introducirlas en consola presionando sobre ellas.



12 Vista general.



 **Atención:** Si se abatiese la cabina se debe esperar, después de dejar la cabina en su posición de marcha, al menos una hora antes de poner el equipo en funcionamiento.

Esquema eléctrico

¡AVISO IMPORTANTE!

Precaución de no invertir las polaridades al conectar el equipo a la batería. Si esto sucediera la placa no se enciende y el equipo no funciona.

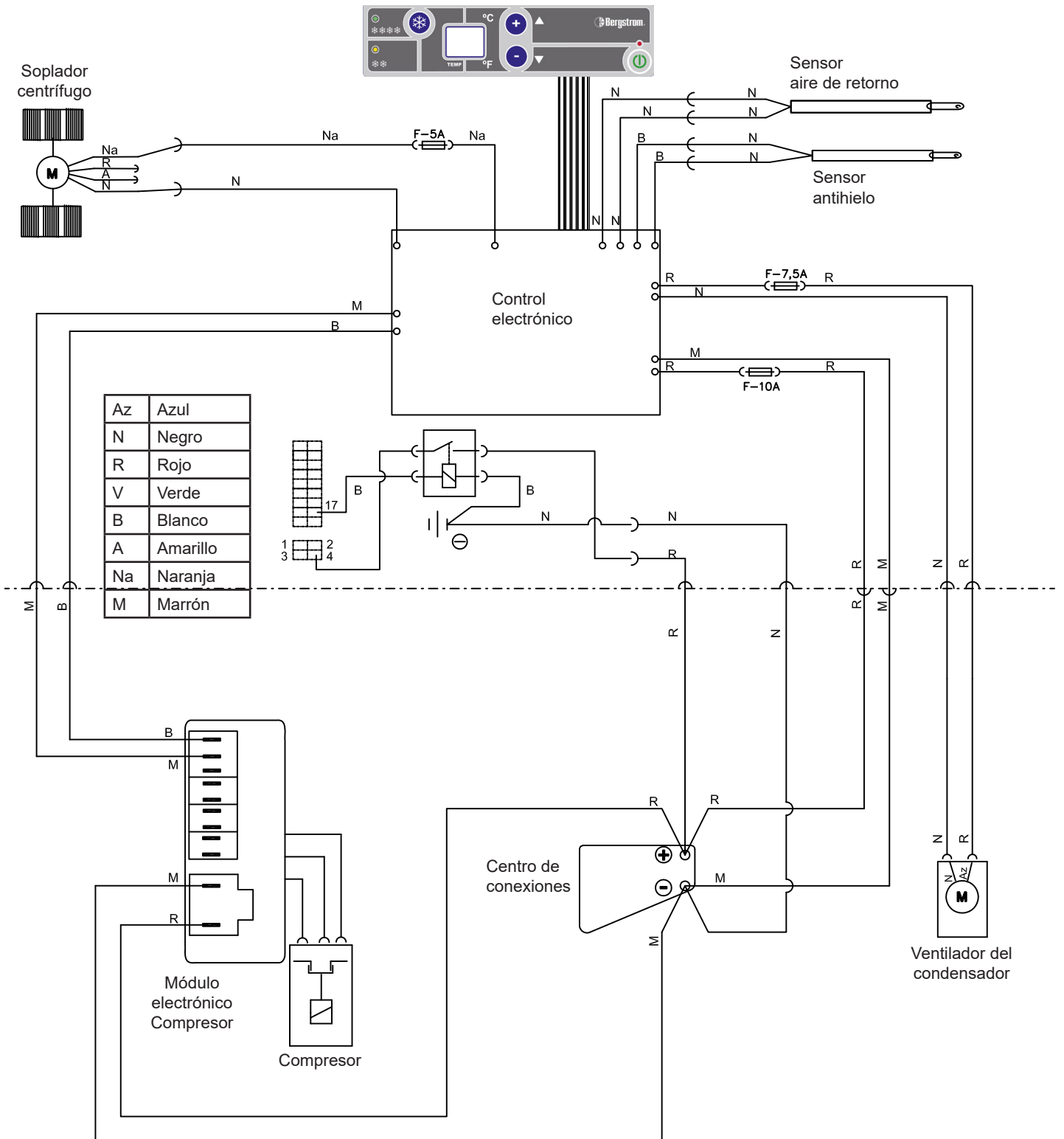

Thank you for placing your trust in our range of products. **LITE** is an air conditioning unit designed and manufactured by **Dirna Bergstrom** to run off a stationary vehicle's engine during rest periods in the shade and/or at night.

LITE is designed with cutting-edge technology to achieve high performance, reduced fuel consumption, and a lower level of CO₂ emissions. These are the features that make it unique on the vehicle air conditioning market.



Read this document carefully before installing the product. Keep this document for future reference. The original documentation was written in Spanish, all other languages are translations.

All product manuals are available in their digital versions (PDF) at <https://www.dirna.com/>

All sales and warranty transactions are subject to our general conditions of sale in their latest version, published on our website <https://www.dirna.com/>

Explanation of symbols



- **Warning:** A safety warning indicating a situation which, if not avoided, could result in death or serious injury.



- **Danger:** Cutting risk. Indicates a situation that could lead to cutting.



- **Danger:** Risk of electrocution. Indicates a situation that could lead to electrocution.



- **Caution:** Safety warning informing about a situation, which if not avoided, could result in damage to the unit or other materials.



- **Information:** Additional information on the installation or handling of the product.



- **Fragile:** Indicates a situation in which care must be taken to avoid damage to the unit and other materials.



Explanation of liability

- **Dirna Bergstrom** accepts no responsibility for damage caused in the following cases:
 - Damage to the product due to mechanical influences and surges.
 - Modifications made to the unit without the manufacturer's express consent.
 - Use of the unit for purposes not described in this document.
 - Improper handling or installation of the unit.
- It is forbidden to tamper with the refrigerant gas circuits without the manufacturer's express authorisation.



Warnings during assembly

- The installation, repair and maintenance of this air conditioning unit may only be carried out by technical staff with sufficient training in vehicle air conditioning, possible dangers and applicable standards.
 - Read the installation instructions carefully before starting to install the unit. During installation, follow the instructions carefully.
 - Switch off the ignition key before starting to install the unit.
 - Disconnect the vehicle's battery before starting to install the unit.
 - Install **LITE** securely to prevent it from falling.
 - Use the appropriate tools for each operation.
 - During installation, ensure the connection of the electrical components, checking that they are fitted correctly.
 - If during installation of the unit the cables pass through walls with sharp edges, use conduits or guides to prevent damage to the cables.
 - If during installation the unit is tilted, or the cab is tilted with the unit installed on top, you must wait at least 60 minutes after placing the unit in horizontal position before it is started.
 - Unit pre-charged with r-134a refrigerant gas.
- **Important:** When connecting the unit make sure the polarities are not reversed. If this happens, the control board will not switch on and the unit will not operate.



**Tools required for assembly**

- Torx wrenches set.
- Allen wrenches set.
- Open-jawed spanner 10, 13, 14.
- Scissors.
- Flexo-meter.

**Proper use of the product**

- **LITE** is a roof-mounted air conditioning unit suitable only for use in trucks. It is not suitable for installation and operation in agricultural or construction machinery subject to intense vibrations.
- Non-intended use will void the unit's warranty and exempts the manufacturer from any responsibility.
- If you are not sure how to use **LITE**, read the product's user manual.
- If the temperature in your vehicle's cab is too high for rest, first cool the cab with your vehicle's air conditioning for a few minutes and then run **LITE** to maintain the comfort temperature.

**Associated documentation**

- Quick guide: 1001335086
- User manual: 1001335089
- List of spare parts: 1003229123
- Troubleshooting: 1001335088

Dirna Bergstrom declares that the **LITE** unit complies with the requirements of the following EC Directives and that the harmonised standards and technical specifications listed below have been applied:

- EC Directive 2014/53/EU
- EC Directive 2011/65/EU
- EC Directive 2014/30/EU

1 Take down the original console, pulling on the end of the lights to access the fastening screws. If LEDs are fitted (*), pull on them to remove.



2 Take down the hatch by removing the fastening screws (disconnect cable clamp (*) in electrical hatch).

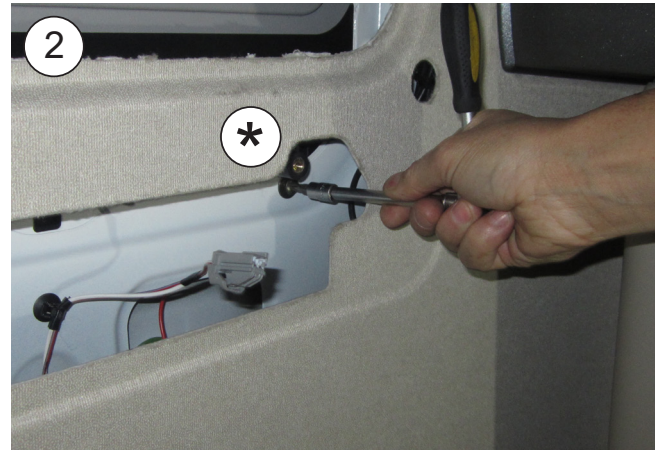

3 Clean the hatch surround and attach 25x15 EPDM seal on the outside of the ridge of the hatch gap.



4 **HOW TO CUT EPDM GASKET TO AVOID WATER FILTRATION INTO THE CABIN**

A- Glue gasket, keeping 100 mm of protection paper at each side.

B- Remove the two pieces of paper.

C- Glue by pressing both ends.

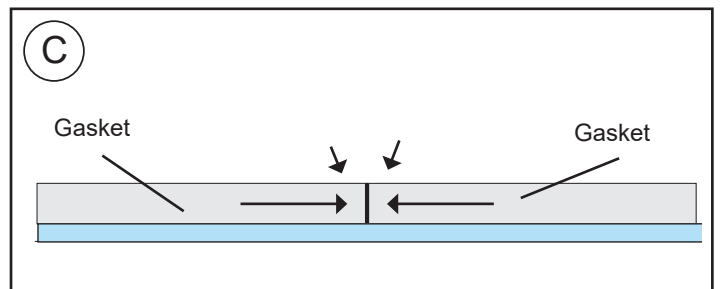
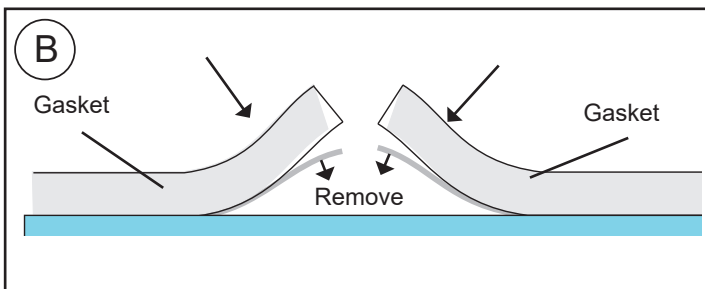
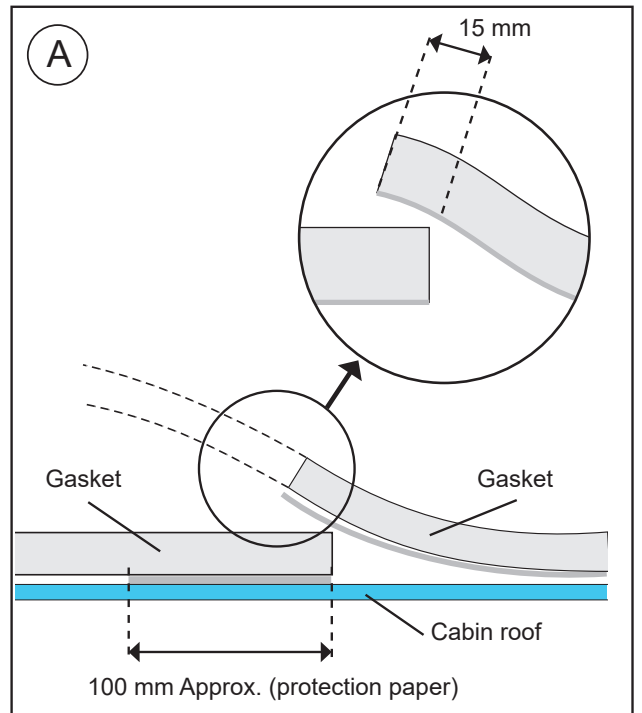

5

Insert (4) M6/100 screws into each attachment support before assembling them to the unit base as shown in the image. As the screws are not secured to the support, be careful when turning the support over to secure it on the base.

**6**

Secure the right attachment support (marked with an "R") and the left attachment support (marked with an "L") to the base of the equipment using (4) grower washers, (4) 8mm flat washers, and (4) M8/125 screws.

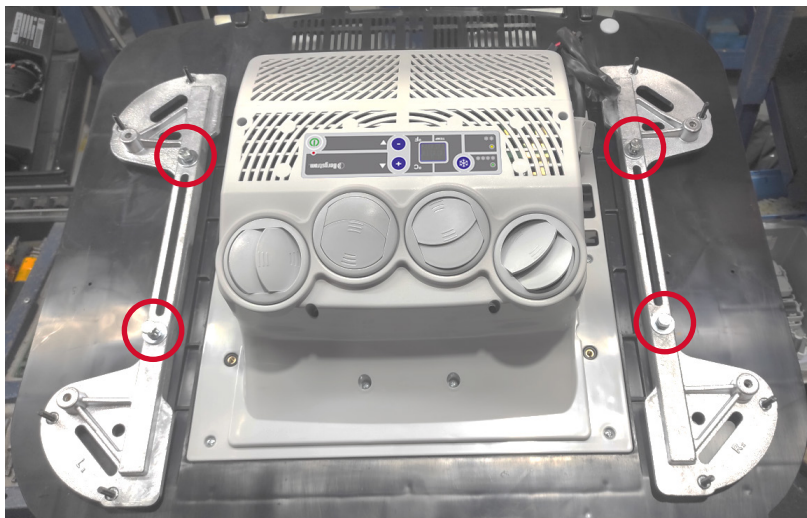

7 Position the unit, fitting the brackets on the hatch gap.

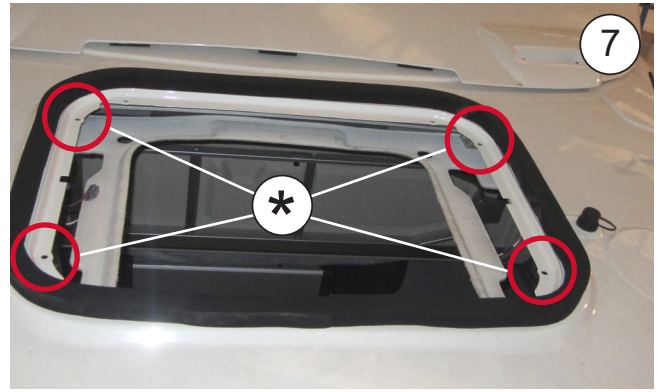

8 Thread (8) M6/100 nuts with washer on each stud of the brackets. Tighten them with a torque of $10 \pm 10\%$ Nm.

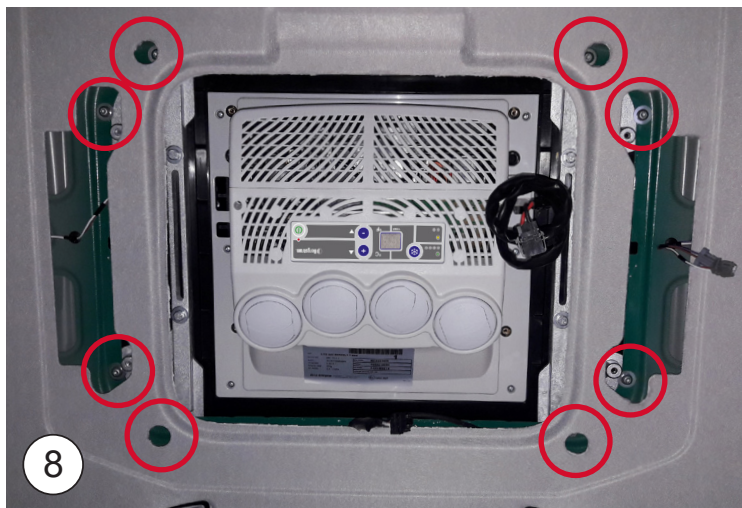

CABLE CONNECTION

9

Run power cables to the hatch and secure the supplied terminals on them, positioning the supplied 2-way box.

Caution: Match the cables as indicated R= (+) and N= (-).

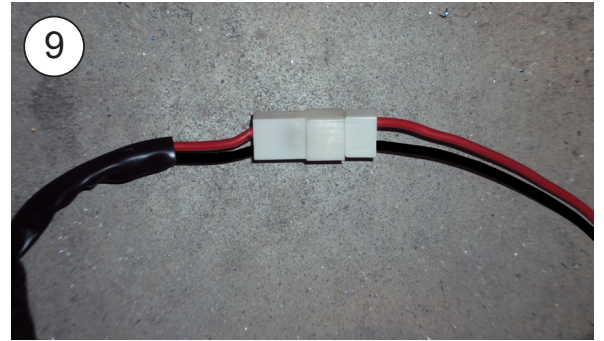

Caution: The cable to be installed must be 6 mm section; the (+) cable must be protected with a 30A fuse.

Important: Due to the equipment's complex electronic regulation system, the current connection must be made directly to the battery point or authorised connection point, and not to any other point which services other accessories of the vehicle, taking the precaution to not invert polarity when making the connection.

Important: Check the **user manual for starting up**.

10

Position the console on the front and secure it with (4) 6/100x30 screws with washer, screwing onto the indicated bracket spacers with a torque of $3.0 \pm 10\%$ Nm.

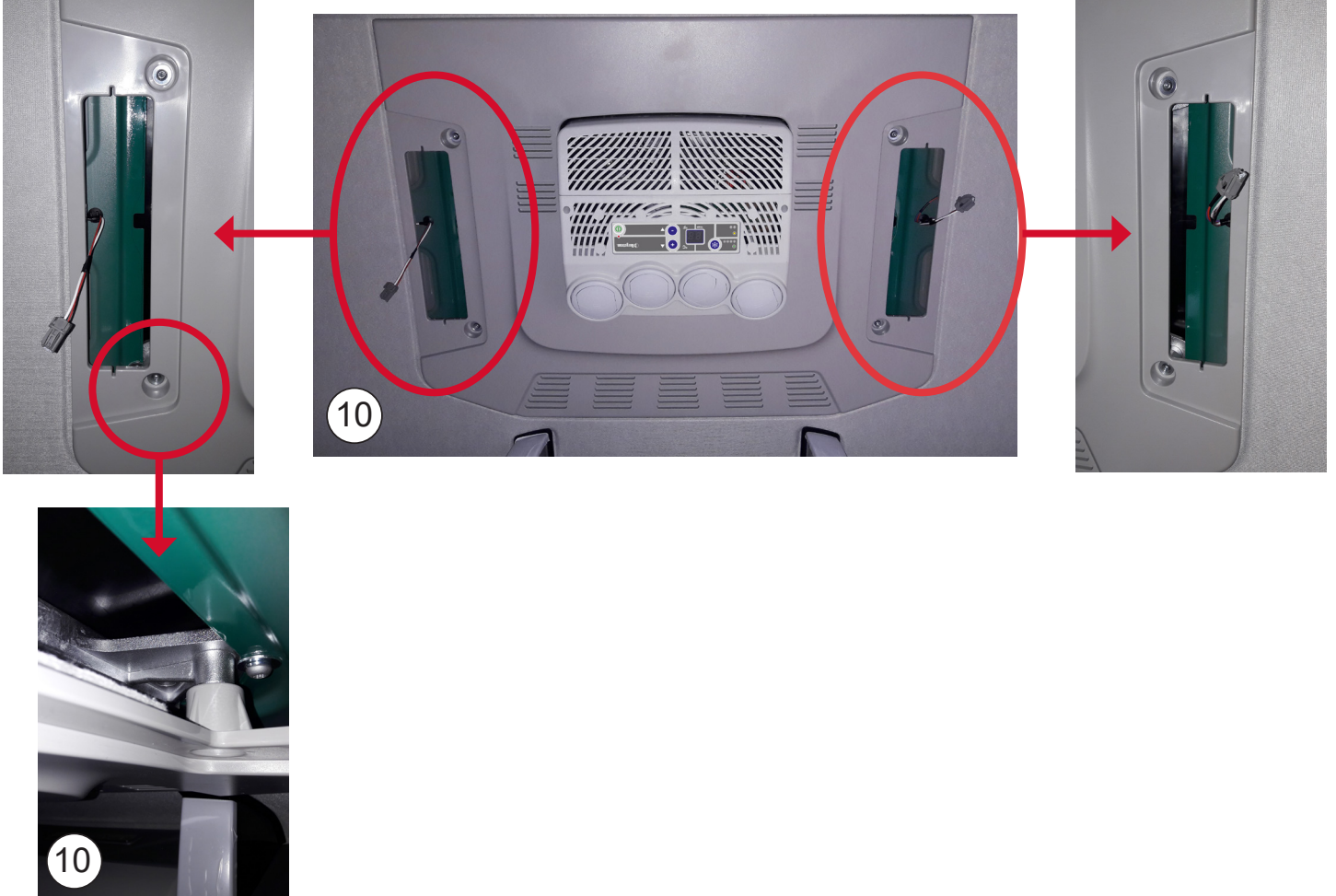
**11**

Connect the lights and introduce them in the console by pressing on them.



12 Overview.



 **Caution:** If the cabin is tilted forward, wait for at least one hour once the cabin is in driving position before starting up the unit.

Wiring diagram

IMPORTANT WARNING!

Take care not to invert the polarities when connecting the unit to the battery. If this happens, the plate does not come on and the unit does not work.

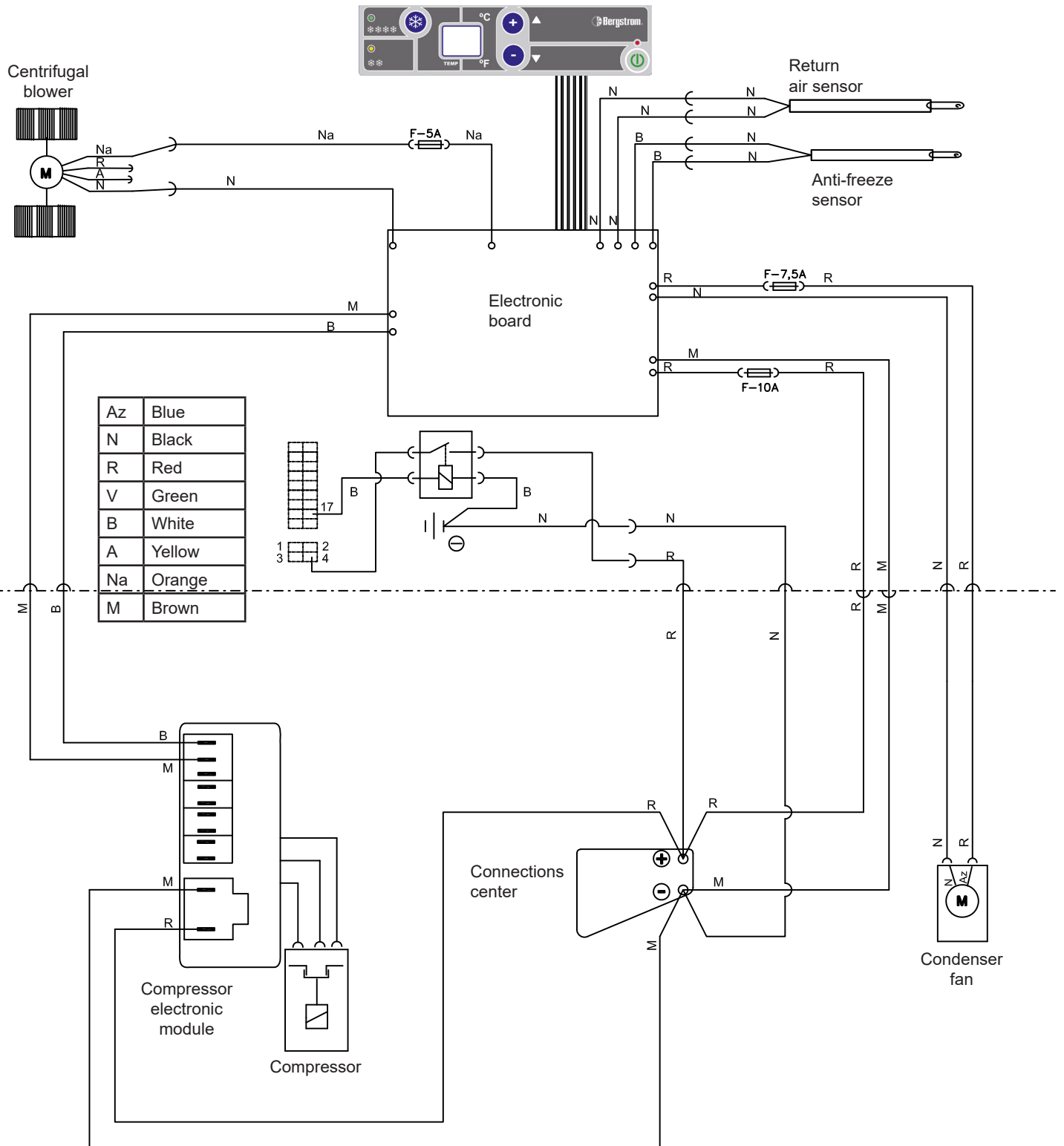

Nous vous remercions de votre achat et de la confiance témoignée à notre gamme de produits. **LITE** est une unité de climatisation conçue et fabriquée par **Dirna Bergstrom** pour une utilisation dans un véhicule avec le moteur à l'arrêt pendant les périodes de repos à l'ombre et/ou la nuit.

LITE est conçue avec la technologie la plus avancée pour obtenir des performances efficaces, une consommation réduite de carburant et diminuer les émissions de CO₂ dans l'atmosphère. Grâce à ces particularités, elle est unique sur le marché de la climatisation pour véhicules.



Veillez lire attentivement ce document avant d'installer le produit. Conservez ce document pour toute référence ultérieure.

La documentation d'origine a été rédigée en espagnol, les autres langues sont donc des traductions.

Vous avez à votre disposition tous les manuels des produits dans leurs versions numériques (PDF) sur <https://www.dirna.com/>

Toute opération de vente ou de garantie est soumise à nos conditions générales de vente dans leur version la plus à jour, publiée sur notre site Web <https://www.dirna.com/>

Explication des symboles



- **Mise en garde** : Avis de sécurité informant d'une situation qui, si elle n'est pas évitée, pourrait conduire à des blessures graves ou la mort.



- **Danger** : Risque de coupure. Signale une situation qui pourrait conduire à une coupure.



- **Danger** : Risque d'électrocution. Signale une situation qui pourrait conduire à une électrocution.



- **Avertissement** : Avis de sécurité informant d'une situation qui, si elle n'est pas évitée, pourrait entraîner des dommages matériels (équipement ou autre).



- **Information** : Information complémentaire sur l'installation ou la manipulation du produit.



- **Fragile** : Indique une situation dans laquelle il faut procéder avec précaution afin de ne pas endommager l'équipement ou d'autre matériel.



Explication des responsabilités

- **Dirna Bergstrom** décline toute responsabilité en termes de dommages causés dans les cas suivants :

- Dommages au produit dus à des influences mécaniques et à des surtensions.
- Modifications apportées à l'équipement sans le consentement exprès du fabricant.
- Utilisation de l'équipement à des fins non décrites dans ce document.
- Manipulation ou installation inappropriée de l'équipement.

- La manipulation des circuits de gaz réfrigérant sans autorisation expresse du fabricant est interdite.



Mises en garde au cours du montage

- L'installation, la réparation et l'entretien de cet équipement de climatisation ne peuvent être réalisés que par un personnel technique suffisamment formé sur la climatisation des véhicules, les dangers éventuels et les normes applicables.
- Lire attentivement les consignes de montage avant de commencer l'installation de l'équipement. Pendant l'installation, suivre au pied de la lettre les consignes indiquées.
- Débrancher la clé de contact avant de commencer l'installation de l'équipement.
- Débrancher la batterie du véhicule avant de commencer l'installation de l'équipement.
- Installez **LITE** en toute sécurité afin d'éviter les chutes.
- Utiliser les outils appropriés à chaque opération.
- Pendant l'installation, s'assurer du raccordement des composants électriques en vérifiant leur bon ajustement.
- Si lors de l'installation de l'équipement, les câbles traversent des murs à arêtes vives, utilisez des conduits ou des dispositifs de guidage, afin d'éviter l'endommagement des câbles.
- Si pendant son installation, l'équipement s'incline ou la cabine se rabat avec l'équipement installé dessus, attendez au moins 60 minutes, à compter du moment où l'équipement est à l'horizontale, avant de le mettre en marche.
- Équipement préchargé en gaz réfrigérant r-134a.



- **Avertissement important** : Faites attention lors du raccordement de l'équipement à ne pas inverser les polarités. Si cela se produit, la carte de commande ne s'allumera pas et l'équipement ne se mettra pas en marche.



Outils requis pour le montage

- Jeu de clés Torx.
- Jeu de clés Allen.
- Clé fixe 10, 13, 14.
- Ciseaux.
- Mètre.



Utilisation appropriée du produit

- **LITE** est une unité de climatisation de toit destinée à être utilisée dans les camions uniquement. Il n'est pas apte pour être installé ou fonctionner sur des machines agricoles ou de construction soumises à des vibrations intenses.
- L'utilisation non conforme à l'usage prévu annule la garantie de l'équipement et exclut la responsabilité du fabricant.
- Si vous n'êtes pas sûr de comment utiliser **LITE**, consultez le mode d'emploi du produit.
- Si la température dans la cabine de votre véhicule est trop élevée pour le repos, refroidissez d'abord la cabine avec la climatisation de votre véhicule pendant quelques minutes, puis mettez le **LITE** en marche afin de maintenir une température confortable.



Documentation connexe

- Guide rapide : 1001335086
- Mode d'emploi : 1001335089
- Liste de pièces de rechange : 1003229123
- Diagnostic de pannes : 1001335088

Dirna Bergstrom déclare que l'équipement **LITE** satisfait aux exigences des Directives CE suivantes, et que les normes et spécifications techniques harmonisées énumérées ci-dessous ont été appliquées :

- Directive CE 2014/53/UE
- Directive CE 2011/65/UE
- Directive CE 2014/30/UE

1

Démonter la console originale, en tirant de l'extrémité des lumières pour accéder aux vis de fixation.

Si la console dispose de leds (*) démonter en tirant de ces dernières.



2

Démonter la trappe en retirant ses vis de fixation (sur les trappe électriques, débrancher leur bornier (*)).

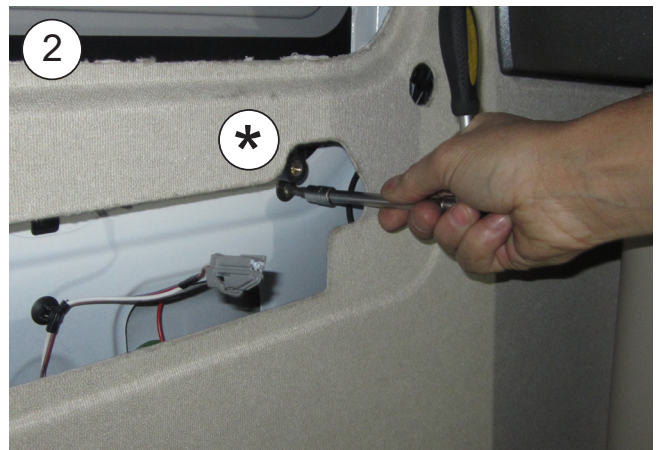

3

Nettoyer le contour de la trappe et coller le joint EPDM 25x15, sur l'extérieur du rebord du contour de l'espace de la trappe.

**4**

COMMENT COUPER LE JOINT EPDM POUR EVITER LES FILTRATIONS DANS LA CABINE

A- Coller le joint en maintenant une protection en papier de 100 mm de chaque côté.

B- Retirer les deux morceaux de papier.

C- Coller en faisant pression sur les deux extrémités.

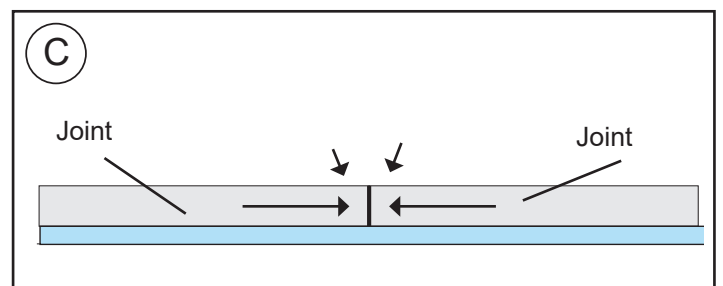
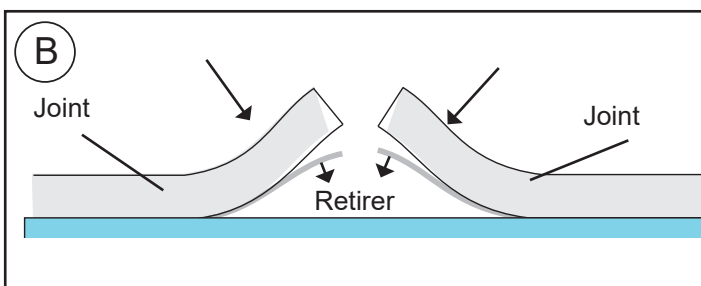
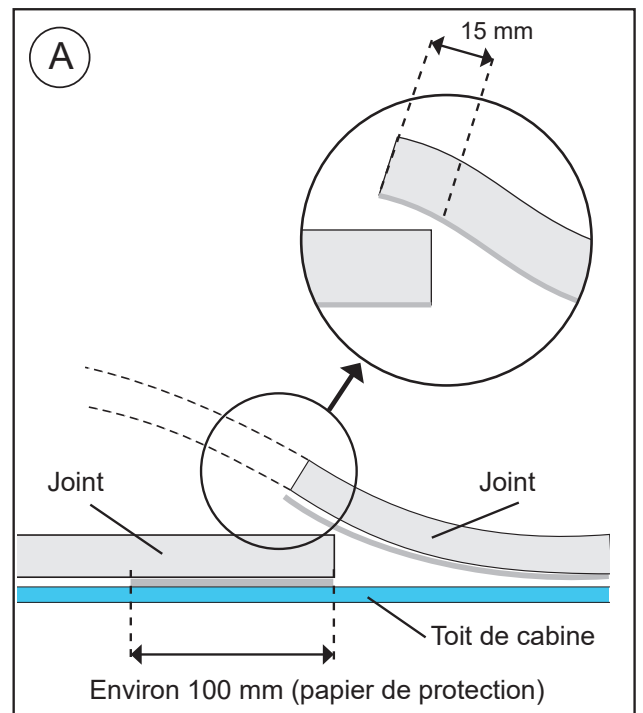

5

Insérer (4) vis M6/100 dans chaque support de fixation avant de les monter dans la base de l'équipement comme indiqué sur l'image. Comme les vis ne sont pas fixées au support, faire attention au moment de tourner le support pour le fixer à la base.

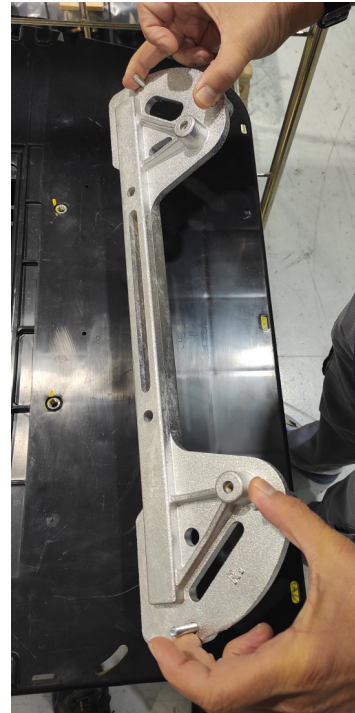
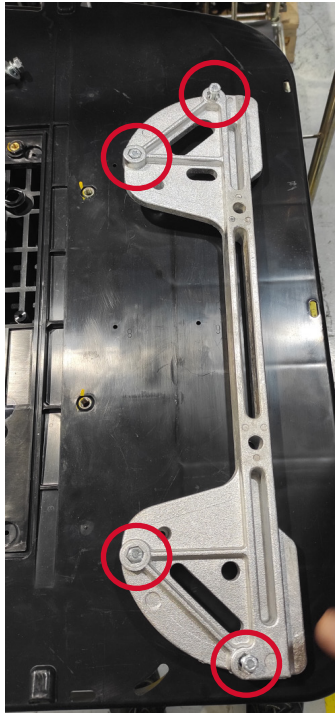
**6**

Fixer le support de fixation droit (marqué avec un "R") et le support de fixation gauche (marqué avec un "L") dans la base de l'équipement avec (4) rondelles grower, (4) rondelles plates de 8 mm et (4) vis M8/125.

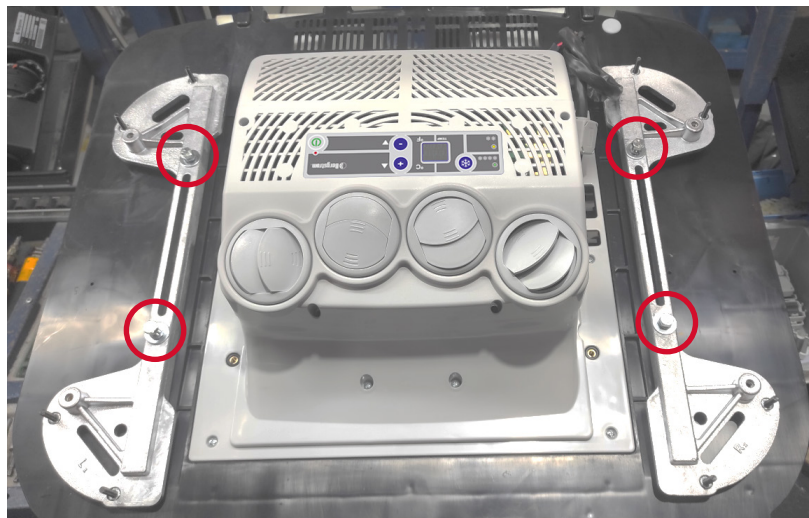

7

Positionner l'appareil en emboîtant les supports dans l'espace de la trappe.

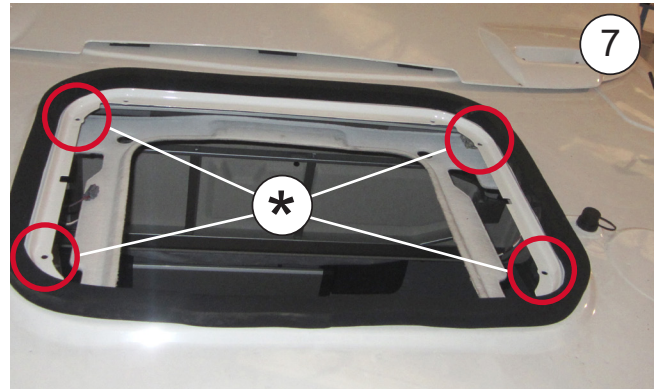
**8**

Visser (8) écrous M6/100 avec rondelle sur chaque goujon des supports. Serrez-les avec un couple de $10 \pm 10\%$ Nm.

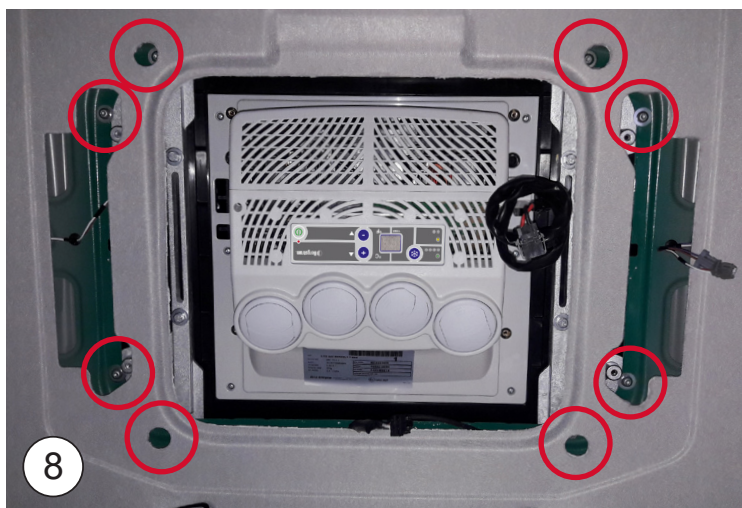

CONNEXION CÂBLAGE

9

Porter les câbles d'alimentation jusqu'à l'écrou et agraffer ces derniers aux terminaux fournis et placer le boîtier à 2 voies fourni.

Attention : Faire coïncider les câbles tel que cela est indiqué R= (+) et N= (-).

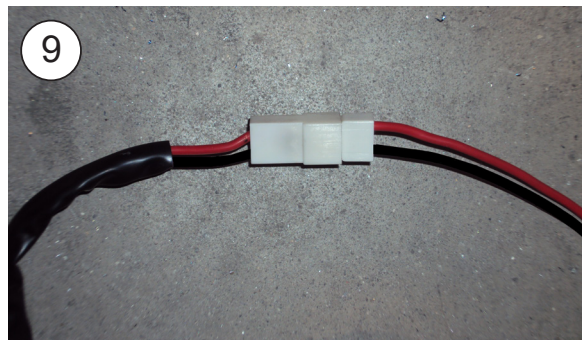

Attention : le câblage à installer doit présenter une section de 6 mm. Le câble (+) doit être protégé avec un fusible de 30A.

Important : En raison de la complexité du système de réglage électronique de l'équipement, la prise de courant doit se faire directement sur la batterie ou prise autorisée, et non sur un tout autre point fournissant des services à d'autres accessoires du véhicule, en faisant attention de ne pas inverser la polarité au moment de la connexion.

Important : Consultez le **Manuel de l'Usager** pour la mise en marche.

10

Introduire la console de face et la fixer avec (4) vis 6/100x30 et rondelle, en vissant sur les séparateurs indiqués des supports avec un couple de serrage de $3,0 \pm 10\%$ Nm.

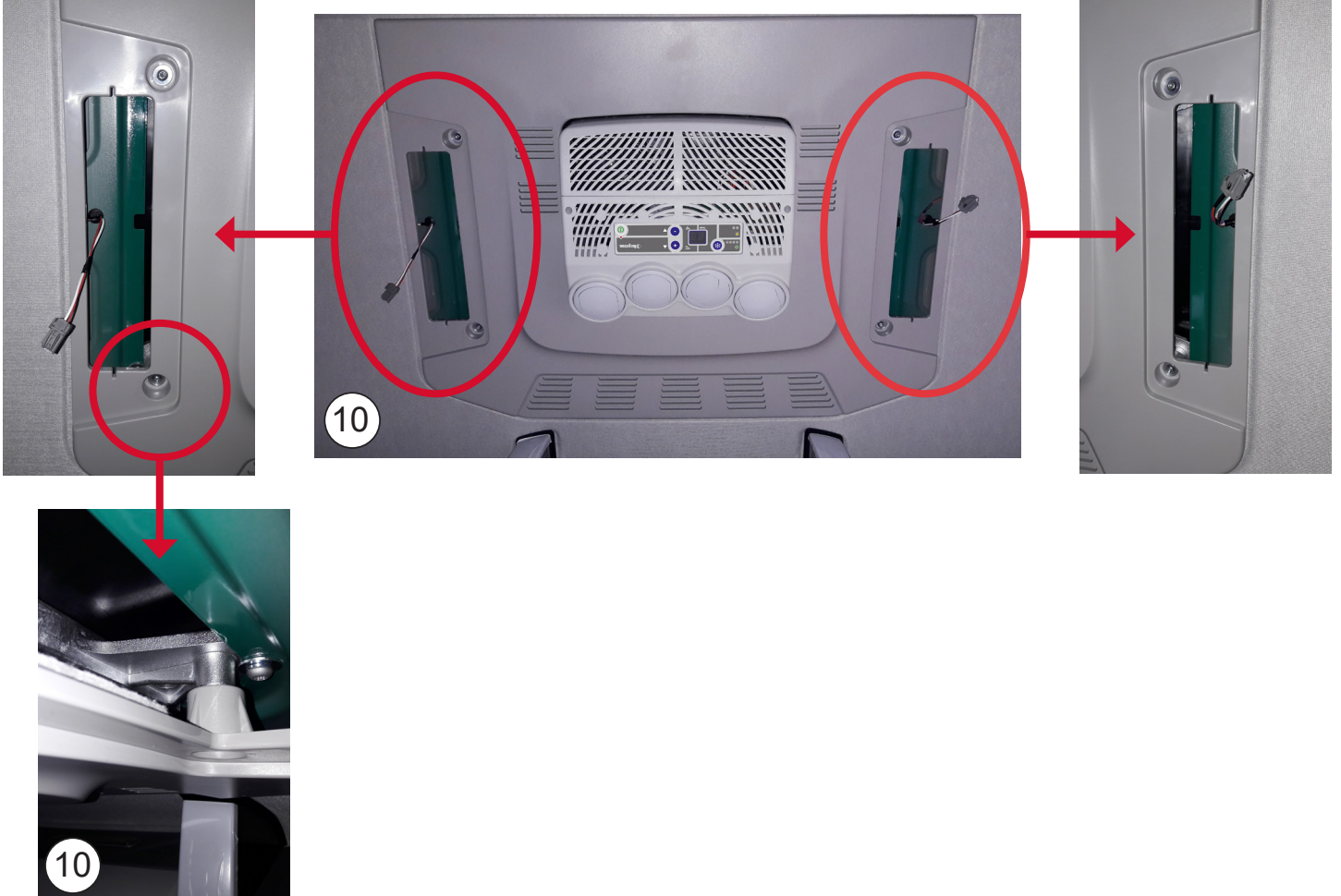
**11**

Connecter les lumières et les introduire dans la console en y faisant pression.



12

Vue générale.



12



Attention: Si la cabine est rabattue, il faut attendre, après avoir laissé la cabine dans sa position de marche, au moins une heure avant de mettre l'appareil en fonctionnement.

Schéma électrique

AVIS IMPORTANT!

Veiller à ne pas inverser les polarités lors de la connexion de l'appareil à la batterie. Dans un cas tel, la plaque ne s'allume pas et l'appareil ne fonctionne pas.

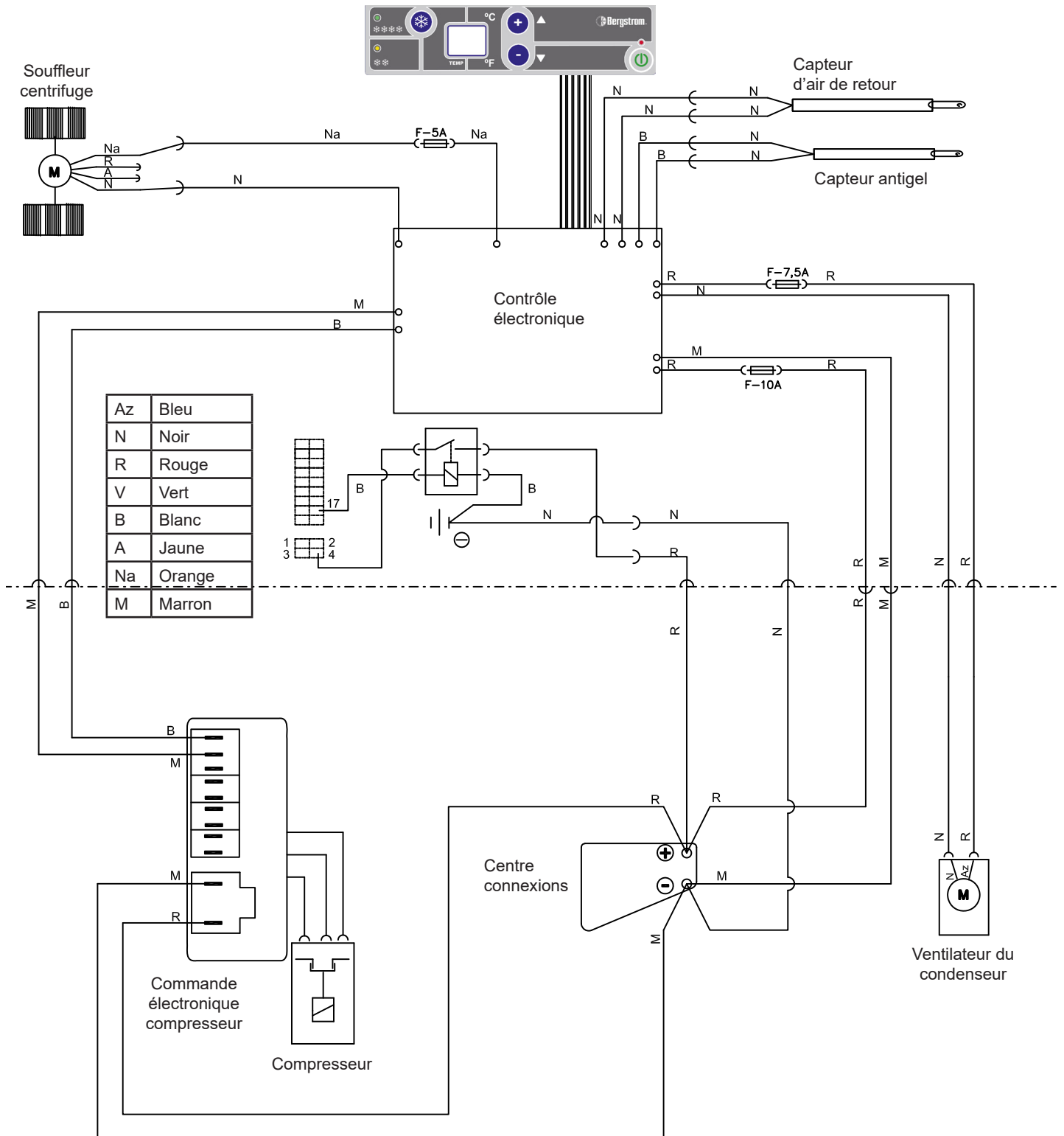

Grazie per l'acquisto e per la fiducia riposta nella nostra gamma di prodotti. **LITE** è un impianto di aria condizionata progettato e prodotto da **Dirna Bergstrom** per essere usato con il motore del veicolo fermo durante i periodi di sosta all'ombra e/o di notte.

LITE è progettato con la tecnologia più avanzata per ottenere ottime performance e ridurre i consumi di combustibile e le emissioni di CO₂ in atmosfera. Proprio grazie a queste caratteristiche, è unico nel mercato dell'aria condizionata per veicoli.



Leggere attentamente questo documento prima di installare il prodotto. Conservare questo documento con cura per poterlo consultare in futuro. La documentazione originale è stata stilata in spagnolo, perciò le altre lingue sono traduzioni.

Tutti i manuali del prodotto sono disponibili in versione digitale (PDF) su <https://www.dirna.com/>

La vendita e la garanzia sono disciplinate dalla versione più aggiornata delle nostre condizioni generali di vendita, pubblicata sul nostro sito web <https://www.dirna.com/>

Spiegazione dei simboli



- **Avvertenza:** Avvertenza di sicurezza riguardo a una situazione che, se non venisse evitata, potrebbe provocare gravi lesioni anche mortali.



- **Pericolo:** Rischio di taglio. Segnala una situazione che potrebbe provocare una lesione da taglio.



- **Pericolo:** Rischio di folgorazione. Segnala una situazione che potrebbe provocare una lesione da folgorazione.



- **Avviso:** Avviso di sicurezza riguardo a una situazione che, se non venisse evitata, potrebbe provocare danni all'impianto o ad altri materiali.



- **Informazioni:** Ulteriori informazioni sull'installazione o sulla gestione del prodotto.



- **Fragile:** Indica una situazione in cui si deve procedere con attenzione per non causare danni all'impianto e ad altri materiali.



Esclusione di responsabilità

- **Dirna Bergstrom** declina ogni responsabilità per eventuali danni causati dai casi seguenti:
 - Danni al prodotto provocati da sollecitazioni meccaniche e sovratensioni.
 - Modifiche effettuate sull'impianto senza esplicita autorizzazione del costruttore.
 - Uso l'impianto per fini diversi da quelli riportati in questo documento.
 - Movimentazione o installazione errata dell'impianto.
- È vietato qualsiasi intervento sui circuiti del gas refrigerante senza esplicita autorizzazione del costruttore.



Avvertenze durante il montaggio

- L'installazione, la riparazione e la manutenzione di questo impianto di aria condizionata possono essere eseguite esclusivamente da personale tecnico in possesso della formazione necessaria nel campo dell'aria condizionata per veicoli, eventuali pericoli e norme applicabili.
- Leggere attentamente le istruzioni di montaggio prima di iniziare l'installazione dell'impianto. Durante l'installazione, seguire alla lettera le istruzioni indicate.
- Disinserire la chiave di avviamento prima di iniziare l'installazione dell'impianto.
- Disinserire la batteria del veicolo prima di cominciare l'installazione dell'impianto.
- Installare **LITE** in modo sicuro per evitare cadute.
- Usare gli attrezzi più adatti per ogni operazione.
- Durante l'installazione, assicurare la connessione dei componenti elettrici, verificandone il corretto inserimento.
- Se nell'installazione dell'impianto i cablaggi attraversano pareti con bordi affilati, proteggere adeguatamente i cavi con guaine o passacavi per evitarne il danneggiamento.
- Se durante l'installazione l'impianto viene inclinato o si ribalta la cabina con l'impianto installato, prima di avviarlo occorre attendere almeno 60 minuti dal momento in cui l'impianto è di nuovo in posizione orizzontale.
- Dispositivo precaricato con gas refrigerante R-134a.



- **Avvertenza importante:** quando si collega l'impianto, fare attenzione a non invertire le polarità. Se ciò dovesse succedere, il quadro comandi non si accende e l'impianto non si avvia.



Attrezzi necessari per il montaggio

- Kit di chiavi Torx.
- Kit di chiavi Allen.
- Chiave fissa 10, 13, 14.
- Forbici.
- Metro a nastro.



Corretto uso del prodotto

- **LITE** è un impianto di aria condizionata da installare sul tetto ed è destinato esclusivamente ai camion. Non è adatto a macchinari agricoli, né per l'edilizia soggetti a forti vibrazioni.
- L'uso non conforme a quello previsto comporta l'annullamento della garanzia dell'impianto e l'esclusione di responsabilità da parte del costruttore.
- In caso di incertezze riguardo all'uso di **LITE**, consultare il manuale dell'utente del prodotto.
- Se la temperatura nella cabina del veicolo è molto elevata per un riposo confortevole, raffreddare la cabina con l'aria condizionata del veicolo per qualche minuto e quindi avviare **LITE** per mantenere la temperatura di comfort.



Documenti correlati

- Guida rapida: 1001335086
- Manuale dell'utente: 1001335089
- Elenco dei pezzi di ricambio: 1003229123
- Diagnosi dei guasti: 1001335088

Dirna Bergstrom dichiara che l'impianto **LITE** soddisfa i requisiti delle seguenti direttive CE e che sono state applicate le norme e le specifiche tecniche armonizzate riportate di seguito:

- Direttiva CE 2014/53/EU
- Direttiva CE 2011/65/EU
- Direttiva CE 2014/30/EU

1 Smontare la console originale, tirando l'estremità delle luci per accedere alle viti di fissaggio.

In presenza di led (*), smontare staccandoli.



2 Smontare il tettuccio apribile svitando le viti di fissaggio (se elettrico, disinserire il morsetto *).

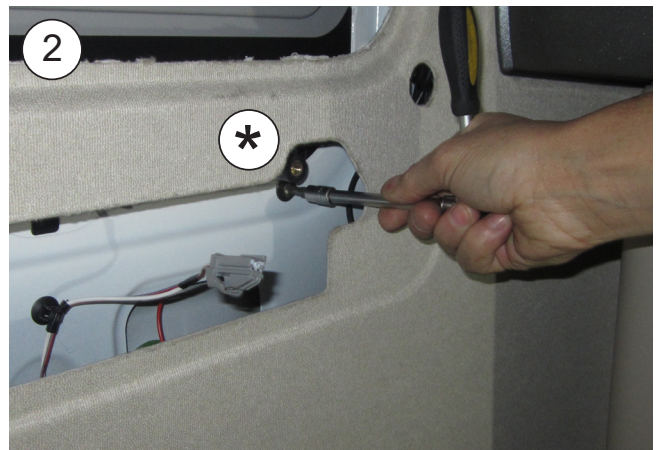

3

Pulire il perimetro del tettuccio apribile e incollare la guarnizione EPDM 25x15 sull'esterno della sporgenza perimetrale del vano.

**4**

INCOLLARE LA GUARNIZIONE EPDM INTORNO AL FORO DELL'OBLÒ (VEDI PARTICOLARE PER TAGLIARE I BORDI)

A- Incollare la guarnizione mantenendo una protezione di carta di 100 mm su ogni lato.

B- Rimuovere i due pezzi di carta.

C- Incollare premendo su entrambe le estremità.

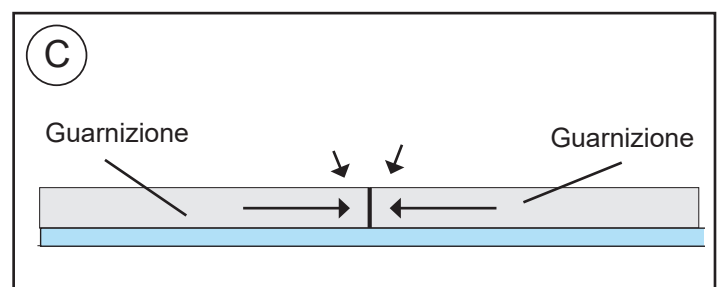
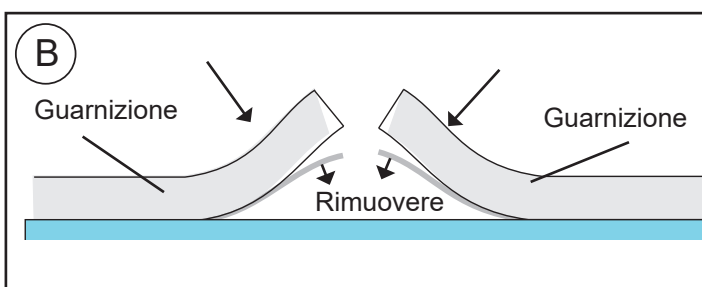
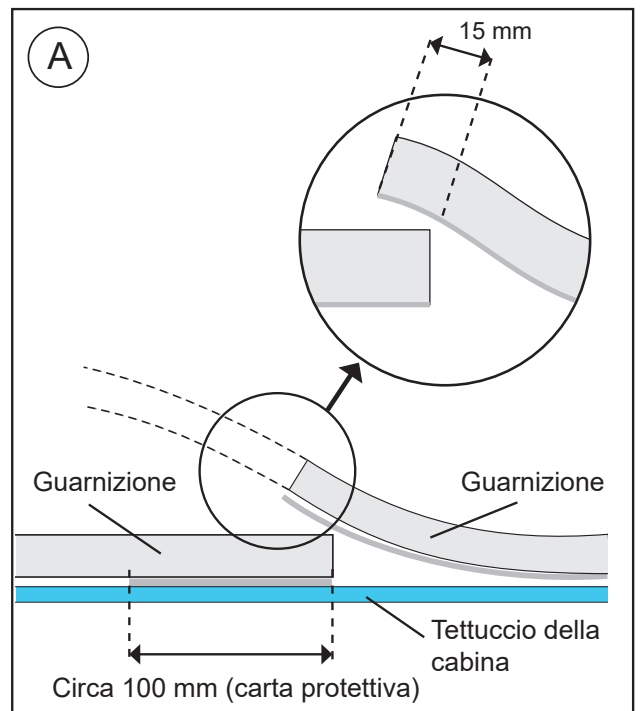

5

Inserire (4) viti M6/100 in ogni supporto di fissaggio prima di montarlo sulla base dell'impianto come illustrato nell'immagine. Non essendo ancora avvitate le viti al supporto, fare attenzione a capovolgere il supporto per fissarlo alla base.

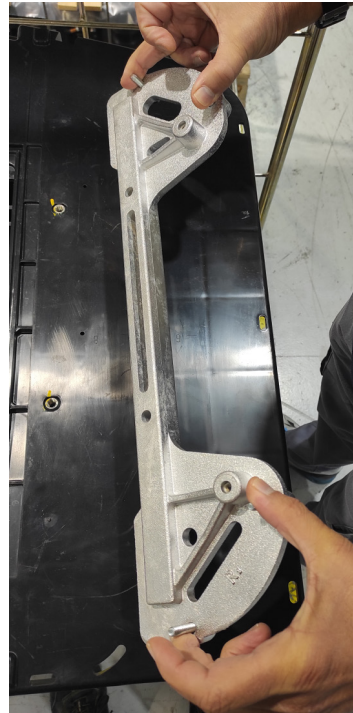
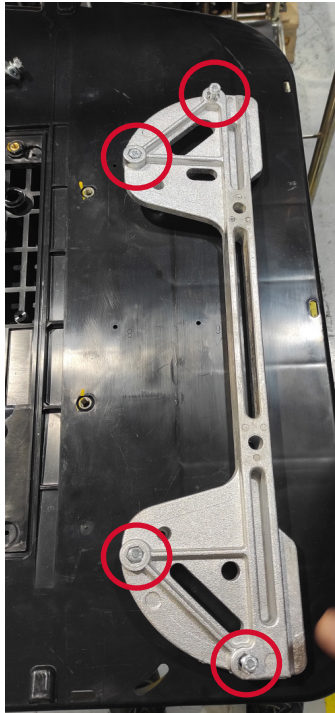
**6**

Montare il supporto di fissaggio destro (contrassegnato da una "R") e il supporto di fissaggio sinistro (contrassegnato da una "L") sulla base dell'impianto impiegando (4) rondelle grower, (4) rondelle piane da 8 mm e (4) viti M8/125.

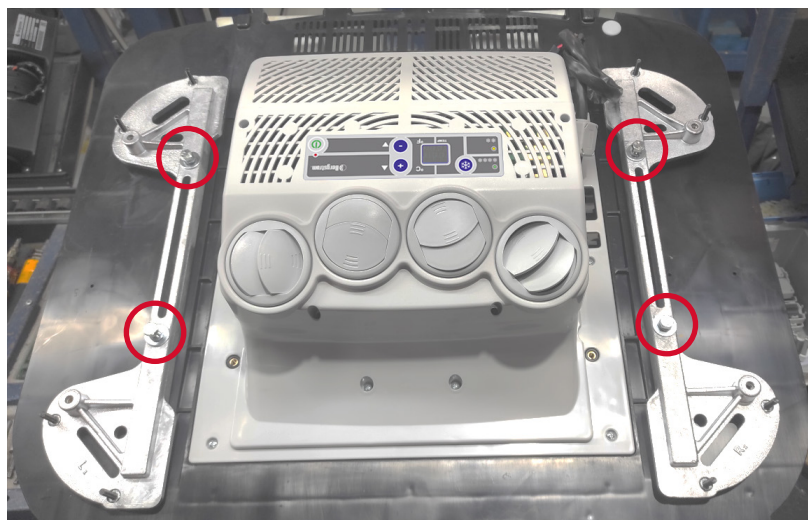

7

Montare l'impianto incastrando i supporti nel vano del tettuccio apribile.

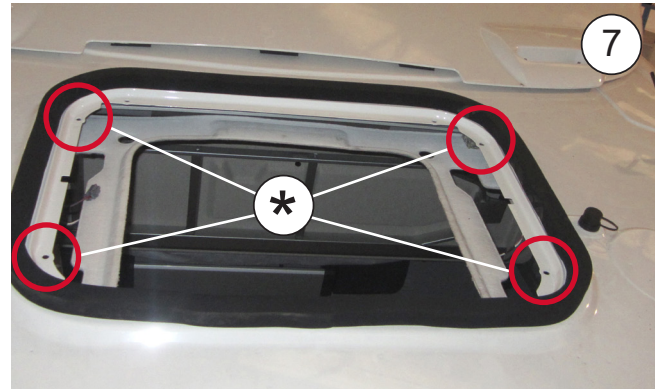
**8**

Avvitare (8) dadi M6/100 con relativa rondella su ogni vite prigioniera dei supporti. Stringerli con una coppia di $10 \pm 10\%$ Nm.



CONNESSIONE DEL CABLAGGIO

9

Condurre i cavi di alimentazione fino al tettuccio apribile e aggarrarvi i terminali in dotazione, quindi montare la scatola a 2 vie in dotazione.

Attenzione: fare coincidere i cavi come indicato R= (+) e N= (-).

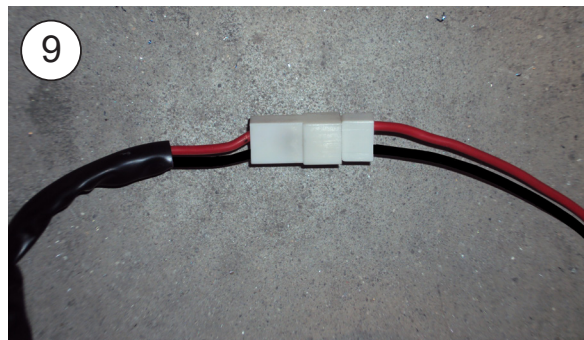

Attenzione: il cablaggio da installare deve essere di 6 mm di sezione, il cavo (+) deve essere protetto con un fusibile da 30A.

Nota bene: dato il complesso sistema di regolazione elettronica dell'impianto, la corrente deve essere presa direttamente dalla batteria o un punto autorizzato, non da qualsiasi altro punto che eroga ad altri accessori del veicolo, facendo attenzione a non invertire la polarità nella connessione.

Nota bene: Per l'avviamento, vedi il **Manuale dell'utente**.

10

Inserire la console nel frontalino e fissarla con (4) viti 6/100x30 con relativa rondella, avvitando sui distanziatori dei supporti con una coppia di serraggio di $3,0 \pm 10\%$ Nm.

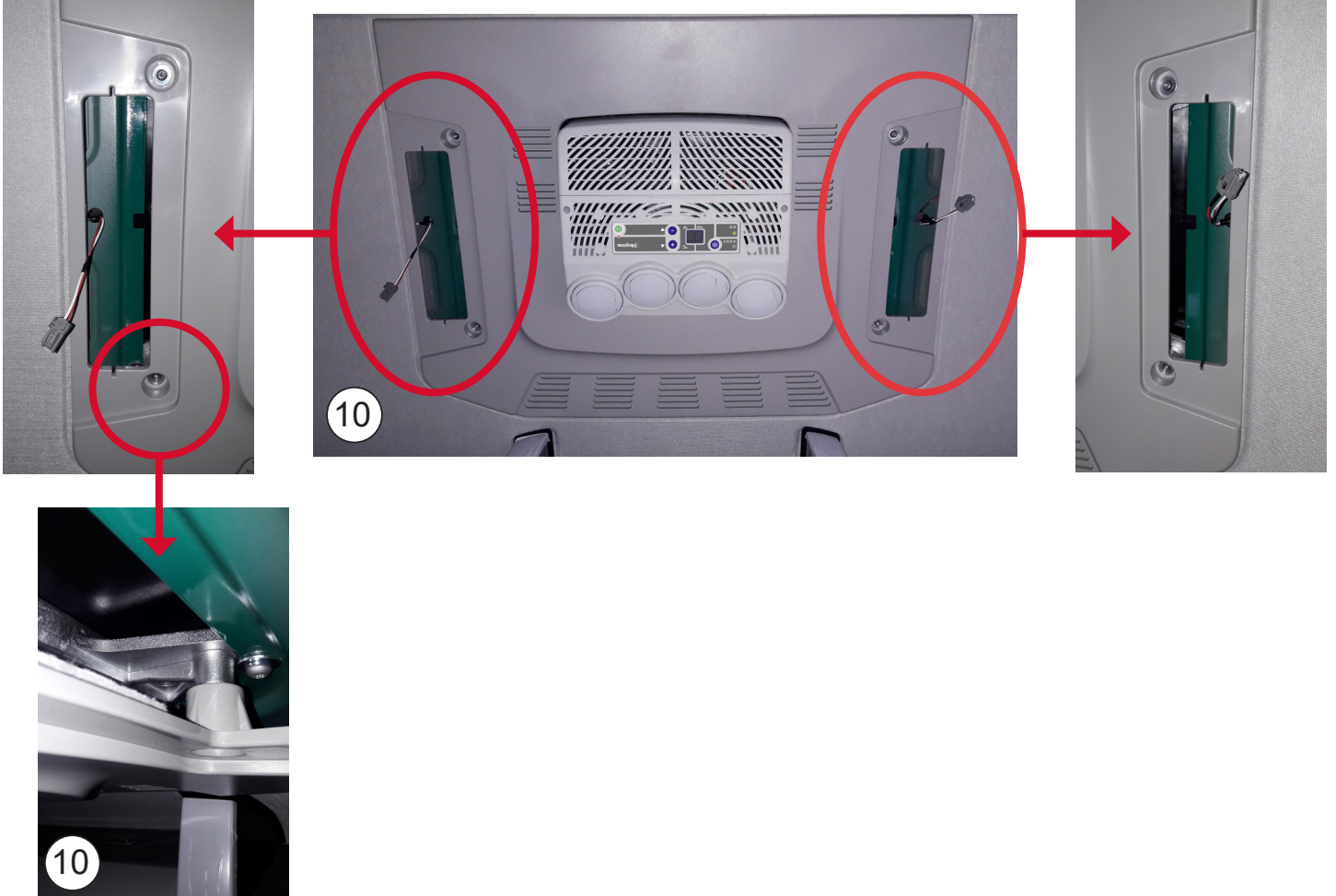
**11**

Collegare le luci e inserirle a pressione nella console.



12

Vista generale.



12



Attenzione: In caso di ribaltamento della cabina, una volta ripristinata la posizione di marcia della stessa, occorre attendere almeno un'ora prima di mettere in funzione l'impianto.

Schema elettrico

AVVERTENZA IMPORTANTE!

Fare attenzione a non invertire le polarità quando si esegue il collegamento dell'impianto alla batteria. Infatti, in tal caso il quadro comandi non si accende e l'impianto non funziona.

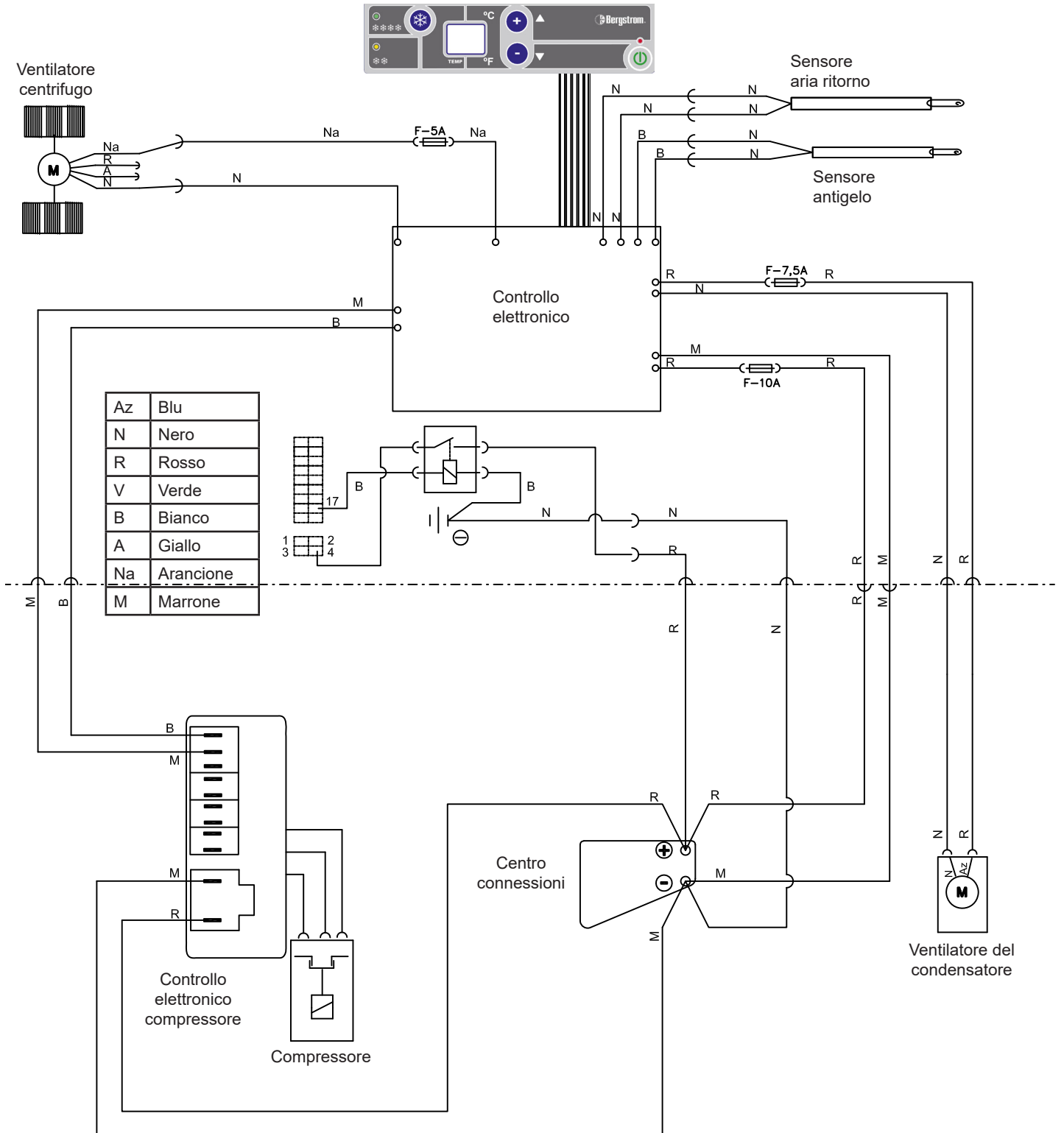

Obrigado pela sua compra e por confiar na nossa gama de produtos. **LITE** é uma unidade de ar condicionado projetada e fabricada pela **Dirna Bergstrom** para ser usada em um veículo motorizado estacionado durante os períodos de descanso na sombra e/ou à noite.

O **LITE** é projetado com a mais avançada tecnologia para obter desempenho eficiente, redução no consumo de combustível e emissões de CO₂ na atmosfera. São essas características que o tornam único no mercado de ar condicionado veicular.



Por favor, leia este documento cuidadosamente antes de instalar o produto.

Guarde este documento para referência futura. A documentação original foi escrita em espanhol, então o restante dos idiomas são traduções.

Todos os manuais de produtos estão disponíveis em suas versões digitais (PDF) em <https://www.dirna.com/>

Qualquer operação de venda ou garantia está sujeita às nossas condições gerais de venda na sua versão mais atualizada, publicadas no nosso website. <https://www.dirna.com/>

Explicação do símbolo



- **Aviso:** Aviso de segurança que informa sobre uma situação que, se não for evitada, pode causar ferimentos graves ou morte.



- **Perigo:** Risco de corte. Indica uma situação que pode causar uma queda de energia.



- **Perigo:** Perigo de eletrocussão. Indica uma situação que pode resultar em eletrocussão.



- **Aviso:** Aviso de segurança que informa sobre uma situação que, se não for evitada, pode causar danos ao equipamento ou a outros materiais.



- **Informação:** Informações adicionais sobre a instalação ou manuseio do produto.



- **Frágil:** Indica uma situação em que se deve ter cuidado para não causar danos a equipamentos e outros materiais.



Explicação das responsabilidades

- **Dirna Bergstrom** declina qualquer responsabilidade por danos causados nos seguintes casos:
 - Danos no produto devido a influências mecânicas e sobretensões.
 - Modificações feitas no equipamento sem o consentimento expresso do fabricante.
 - Uso do equipamento para fins não descritos neste documento.
 - Manuseio ou instalação inadequada do equipamento.
- É proibido manipular os circuitos de gás refrigerante sem a autorização expressa do fabricante.



Avisos durante a montagem

- A instalação, reparação e manutenção deste equipamento de ar condicionado só pode ser realizada por pessoal técnico com formação suficiente em ar condicionado para veículos, possíveis perigos e regulamentos aplicáveis.
- Leia atentamente as instruções de montagem antes de iniciar a instalação do equipamento. Durante a instalação, siga as instruções indicadas ao pé da letra.
- Desligue a chave de ignição antes de iniciar a instalação do equipamento.
- Desligue a bateria do veículo antes de iniciar a instalação do equipamento.
- Instale o **LITE** com segurança para evitar quedas.
- Use as ferramentas certas para cada operação.
- Durante a instalação, certifique-se da ligação dos componentes elétricos, verificando o seu correto encaixe.
- Caso a fiação passe por paredes com arestas vivas na instalação do equipamento, utilize eletrodutos ou guias para evitar que os cabos sejam danificados.
- Caso o equipamento tombe durante a instalação, ou a cabine desmorone com o equipamento instalado sobre ela, deve-se aguardar no mínimo 60 minutos, a partir da colocação do equipamento na horizontal, antes de colocá-lo em funcionamento.
- Equipamento pré-carregado com gás refrigerante r-134a.



- **Aviso Importante:** Tenha cuidado ao conectar o equipamento para não inverter as polaridades. Se isso acontecer, o painel de controle não ligará e o equipamento não iniciará.



Ferramentas necessárias para a montagem

- Conjunto de chaves Torx
- Chave fixa 10, 13, 14
- Tesoura
- Flexômetro
- Chave de fenda



Uso correto do produto

- O **LITE** é um ar condicionado de tejadilho adequado apenas para utilização em caminhões. Não é adequada a sua instalação e operação em máquinas agrícolas ou de construção sujeitas a vibrações intensas.
- O uso em desacordo com o uso pretendido anula a garantia do equipamento e exclui a responsabilidade do fabricante.
- Se você não tiver certeza de como usar o **LITE**, consulte o manual do usuário do produto.
- Se a temperatura na cabine do seu veículo for muito alta para descansar, primeiro resfrie a cabine com o ar condicionado do seu veículo por alguns minutos e depois ligue o **LITE** para manter a temperatura de conforto.



Documentação relacionada

- Guia rápido: 1001335086
- Manual de usuário: 1001335089
- Lista de peças de reposição: 1003229123
- Diagnóstico de erro: 1001335088

Dirna Bergstrom declara que o equipamento **LITE** está em conformidade com os requisitos das seguintes diretivas da CE e que as normas harmonizadas e especificações técnicas listadas abaixo foram aplicadas:

- Diretiva CE 2014/53/EU
- Diretiva CE 2011/65/EU
- Diretiva CE 2014/30/EU

1 Desmontar a consola original, retirando a extremidade das luzes para aceder aos parafusos de fixação.
No caso de possuir LED (*) desmontar, retirando-os.



2 Desmontar a escotilha, retirando os parafusos de fixação da mesma (na escotilha elétrica desligar o grampo (*) da mesma).

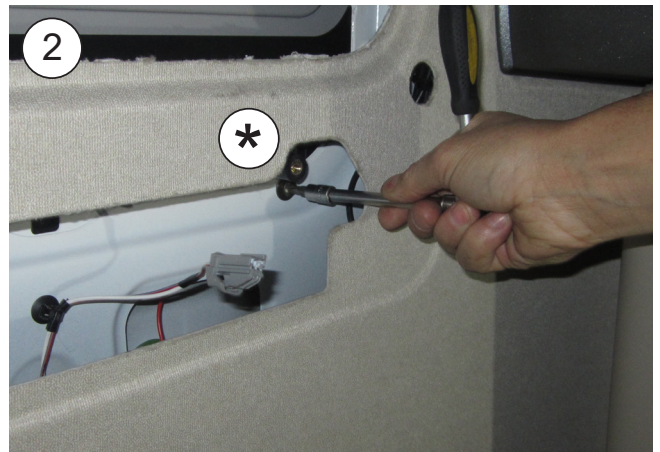

3

Limpar o contorno da escotilha e colar a junta EPDM 25x15 pelo exterior da saliência do contorno da abertura da escotilha.

**4**

COMO CORTAR A JUNTA EPDM PARA EVITAR A FILTRAÇÃO DE ÁGUA NA CABINA

A- Colar a junta, mantendo 100 mm de papel de proteção de cada lado.

B- Retirar as duas peças de papel.

C- Colar pressionando ambas as extremidades.

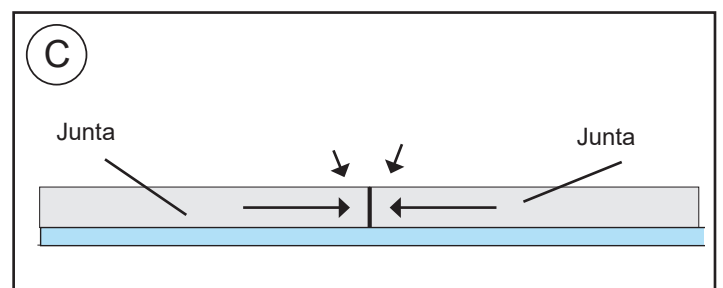
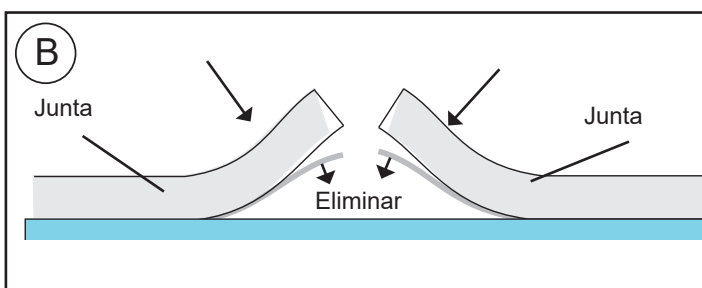
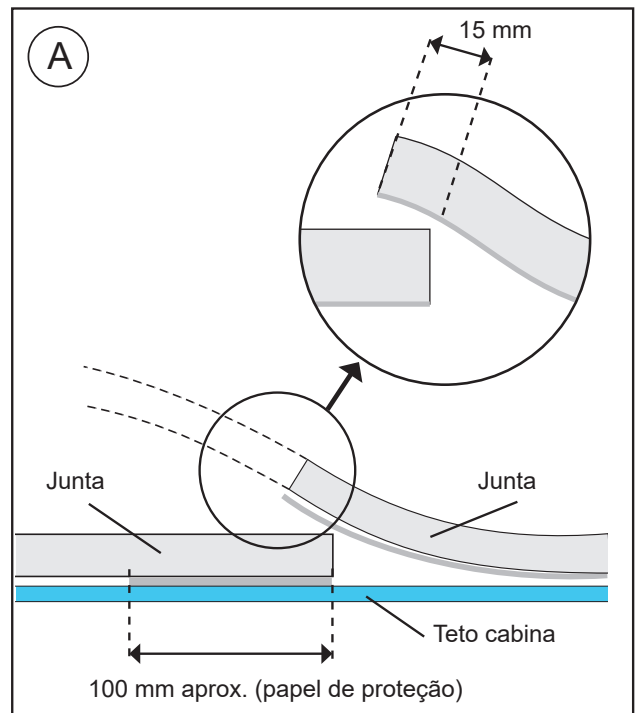

5

Inserir (4) parafusos M6/100 em cada suporte de fixação antes de montá-los na base do equipamento, conforme é mostrado na imagem. Não estando os parafusos fixados no suporte, ter cuidado ao virar o suporte para fixá-lo na base.

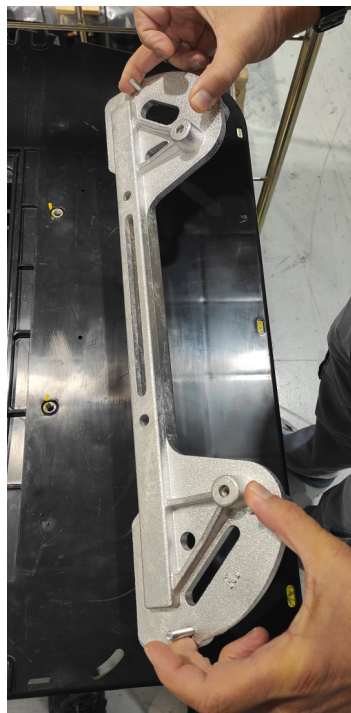
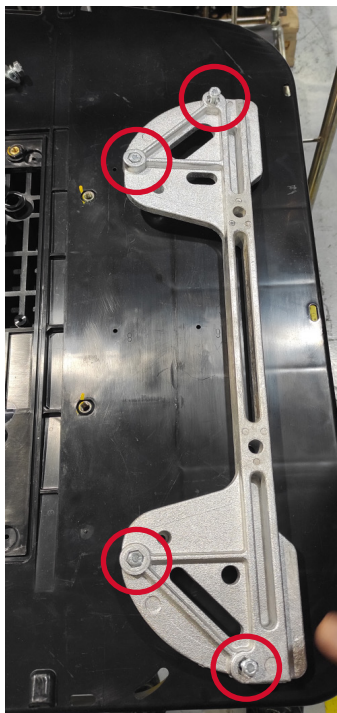
**6**

Fixar o suporte de fixação direito (marcado com um "R") e o suporte de fixação esquerdo (marcado com um "L") na base do equipamento utilizando (4) arandelas grower, (4) arandelas planas de 8 mm e (4) parafusos M8/125.

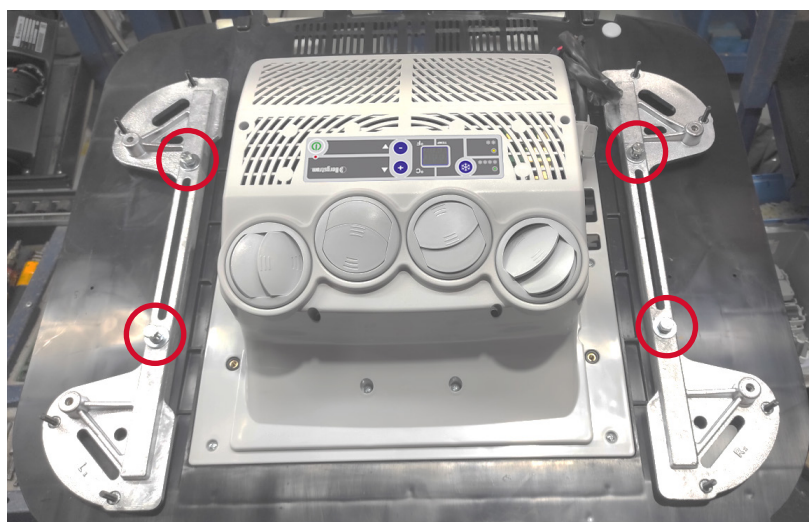

7

Posicionar o equipamento, encaixando os suportes sobre a abertura da escotilha.

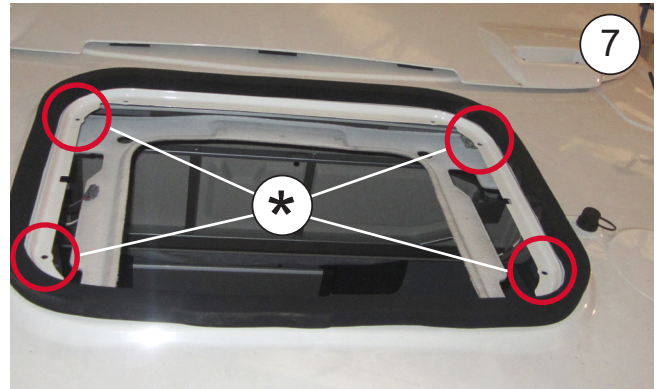
**8**

Roscar (8) as porcas M6/100 com arandela em cada esteio dos suportes. Aperte-os com um torque de $10 \pm 10\%$ Nm.



LIGAÇÃO CABLAGEM

9

Leve os cabos de alimentação à escotilha e grampeie os terminais fornecidos a eles e coloque a caixa de 2 vias fornecida.

Atenção: Combine os cabos conforme indicado R= (+) e N= (-).

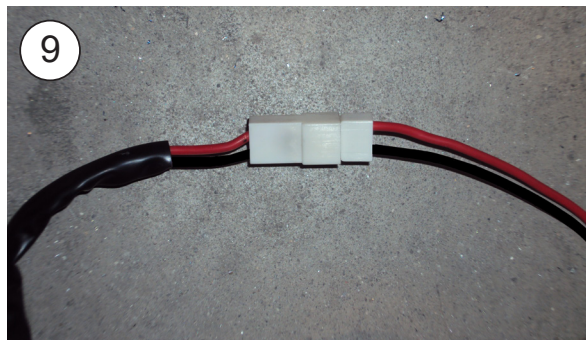

Atenção: A fiação a ser instalada deve ter seção de 6 mm, o cabo (+) deve ser protegido com fusível de 30A.

Importante: Devido ao complexo sistema de regulação eletrônica do equipamento, a alimentação deve ser feita diretamente na bateria ou em ponto autorizado, não em qualquer outro ponto que sirva a outros acessórios do veículo, tomando cuidado para não inverter a polaridade ao fabricante. a conexão.

Importante: Para iniciar consulte o **manual do usuário**.

10

Introduzir a consola na frente e fixá-la com (4) parafusos 6/100x30 com arandela, roscando nos separadores indicados dos suportes com um binário de aperto de $3,0 \pm 10\%$ Nm.

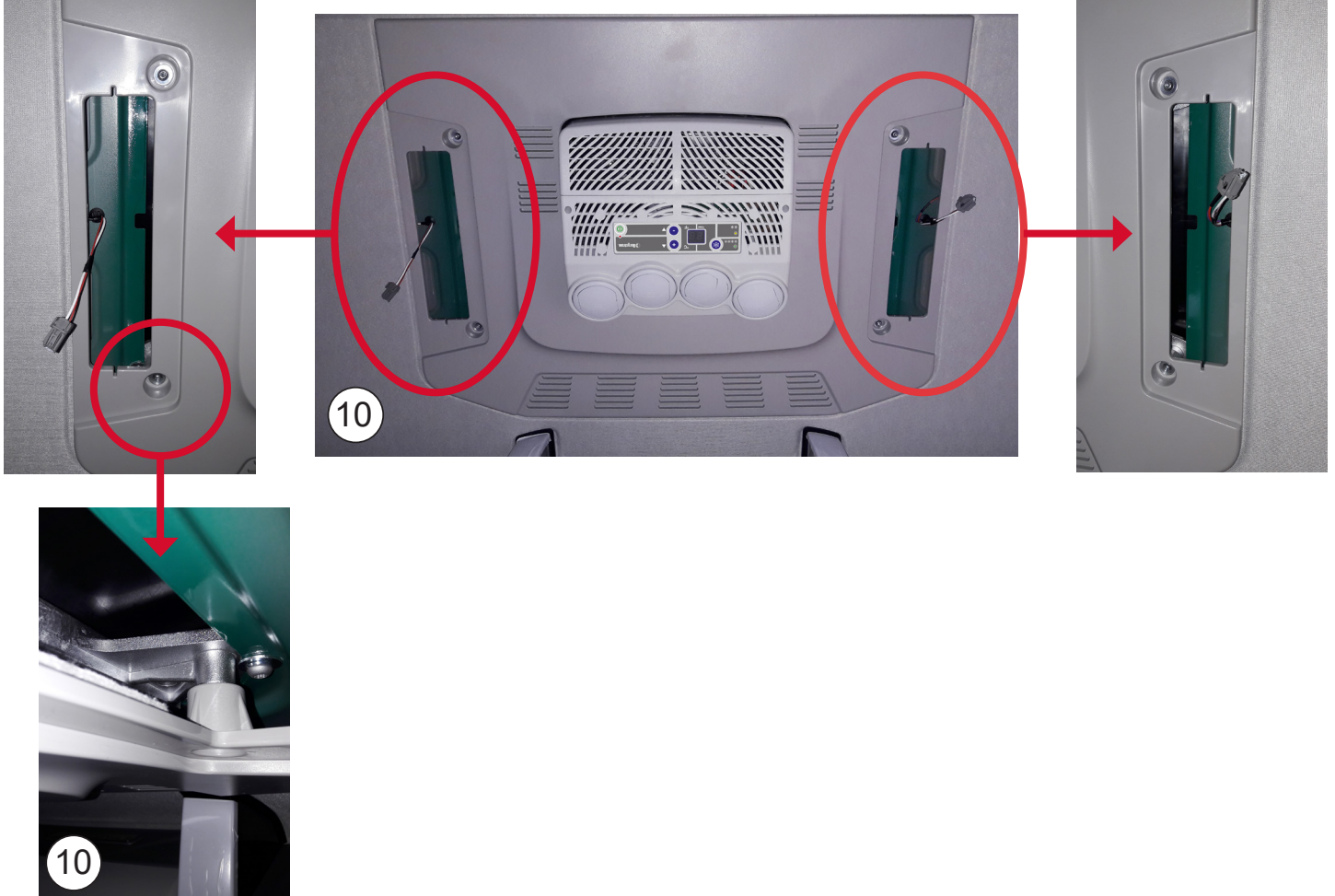
**11**

Ligar as luzes e introduzi-las na consola, pressionando-as.



12

Vista geral.



12



Atenção: Se a cabina abater deverá aguardar, depois de deixar a cabina na respetiva posição de funcionamento, pelo menos uma hora antes de colocar o equipamento em funcionamento.

Esquema elétrico

AVISO IMPORTANTE!

Precaução de não inverter as polaridades ao ligar o equipamento à bateria. Se isto acontecer, a placa não se acende e o equipamento não funciona.

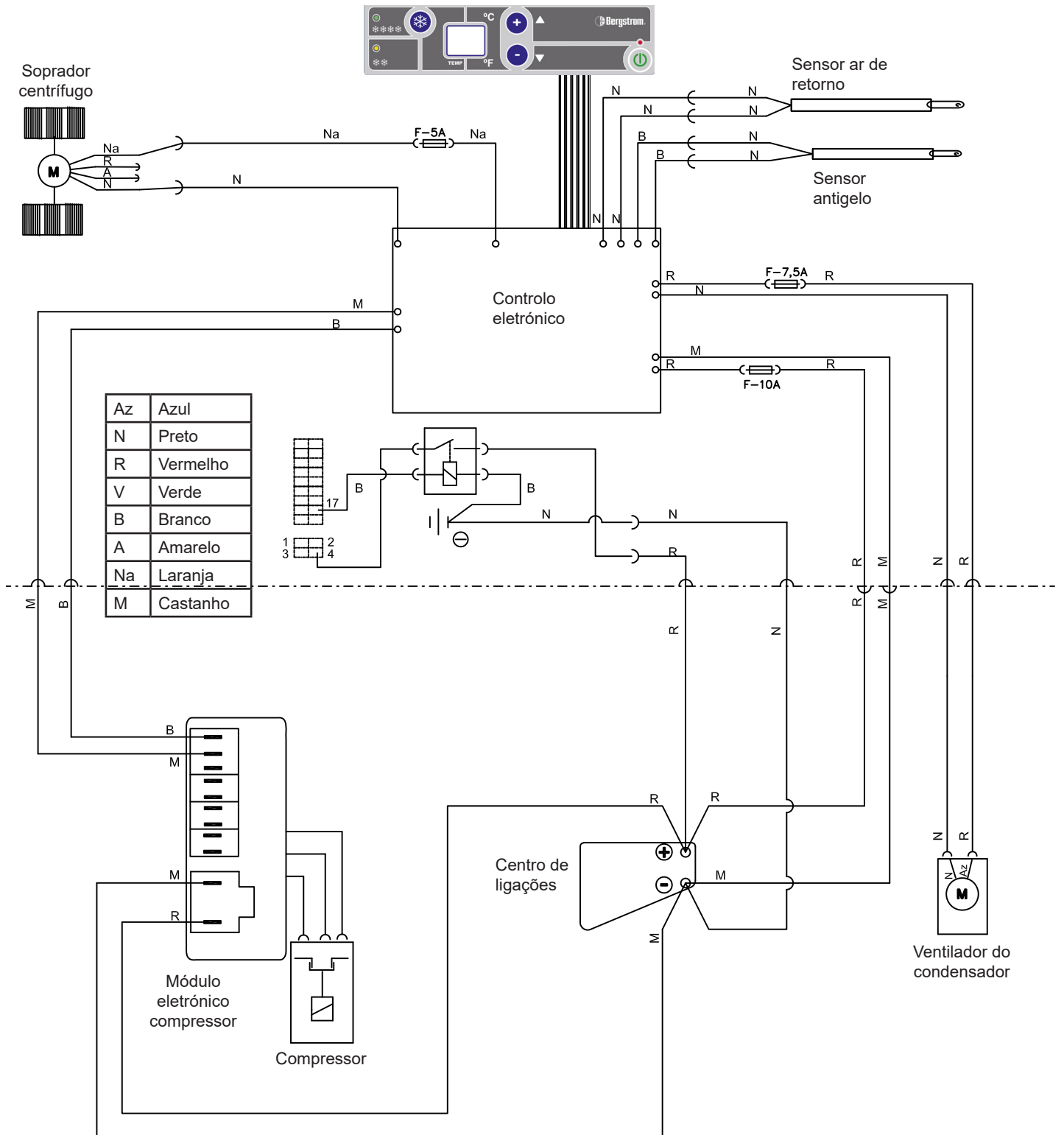

Ed:	01/03/2023
Md:	



Francisco Alonso, 6
28806 Alcalá de Henares, Madrid
SPAIN

Contact	Phone	E-Mail
Sales (Ventas Internacional)	+34 91 8770510	sales@dirna.bergstrominc.com
Comercial Nacional	+34 91 8775841	ventas@dirna.bergstrominc.com
Orders & Deliveries (Logística internacional)	+34 91 8775846	export@dirna.bergstrominc.com
Orders & Deliveries (Logística nacional)	+34 91 8775840	pedidos@dirna.bergstrominc.com
Technical Assistance (Internacional)	+49 511 86679681	technicalassistance@dirna.bergstrominc.com
Technical Assistance (Nacional)	+34 91 8775845	oblanco@dirna.bergstrominc.com

www.dirna.com

	ATENCIÓN:	Bergstrom se reserva el derecho de efectuar modificaciones en cualquier momento de los datos contenidos en esta publicación, por razones técnicas o comerciales.
	NOTE:	<i>For technical and commercial reasons, Bergstrom reserves the right to change the data contained in this brochure.</i>
	ATTENTION:	Bergstrom se réserve le droit d'effectuer à tout moment des modifications des données reprises sur cette publication, pour des raisons techniques ou commerciales.
	HIWEIS:	Bergstrom behält sich vor, aus technischen oder kaufmännischen Gründen jederzeit Änderungen der Angaben dieser Veröffentlichung vorzunehmen.
	ATTENZIONE:	Bergstrom si riserva il diritto di effettuare modifiche in qualsiasi momento ai dati contenuti in questa pubblicazione, per motivi tecnici o commerciali.